

Proportional pressure regulator and proportional flow valve - Series MX-PRO

Product code: MX2-1/2-RCA400

Datasheet creation date: 10/03/2025 00:41

Check the most updated document online [click here](#)



TECHNICAL DATA

Series	MX
Size	2
Port	1/2=G1/2
Functioning	R = pressure regulator
Command	CA = electrical command 4-20 mA
Regulator adjustment range	4 = working pressure 0 ± 7 bar
Design type	0 = relieving
Pressure gauge	0 = without manometer, threaded body
Flow direction	= from left to right (standard)

Proportional pressure regulator and proportional flow valve - Series MX-PRO

Product code: MX2-1/2-RCA400

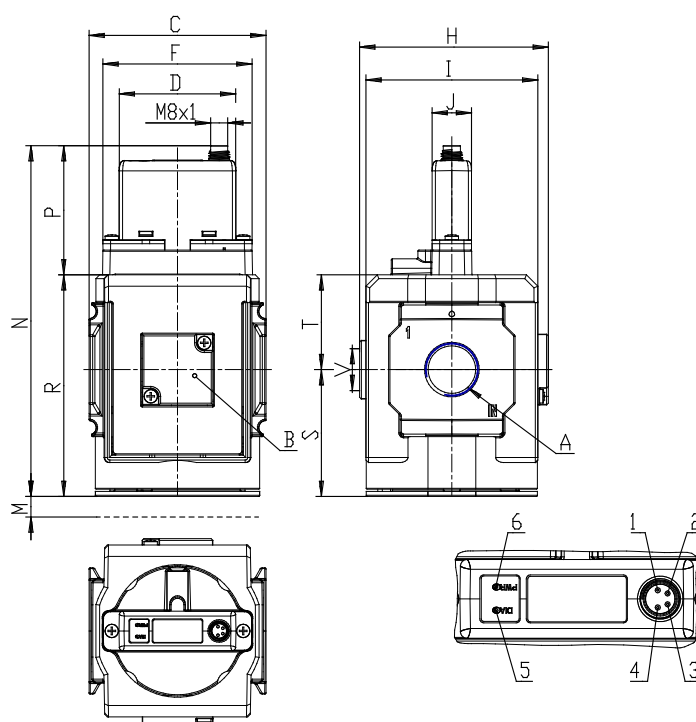

DIMENSIONS

Series	MX
Size	2
Port	1/2=G1/2
Functioning	R = pressure regulator
Command	CA = electrical command 4-20 mA
Regulator adjustment range	4 = working pressure 0 ± 7 bar
Design type	0 = relieving
Pressure gauge	0 = without manometer, threaded body
Flow direction	= from left to right (standard)