

Activated carbon filters - Series MX

Product code: MX2-3/4-FCA1

Datasheet creation date: 20/05/2026 08:05

Check the most updated document online [click here](#)



TECHNICAL DATA

Series	MX
Size	2
Ports (IN - OUT)	3/4 = G3/4
Activated carbon filter	FCA
Visual blockage indicator	1 = present
Flow direction	= from left to right (standard)

Activated carbon filters - Series MX

Product code: MX2-3/4-FCA1

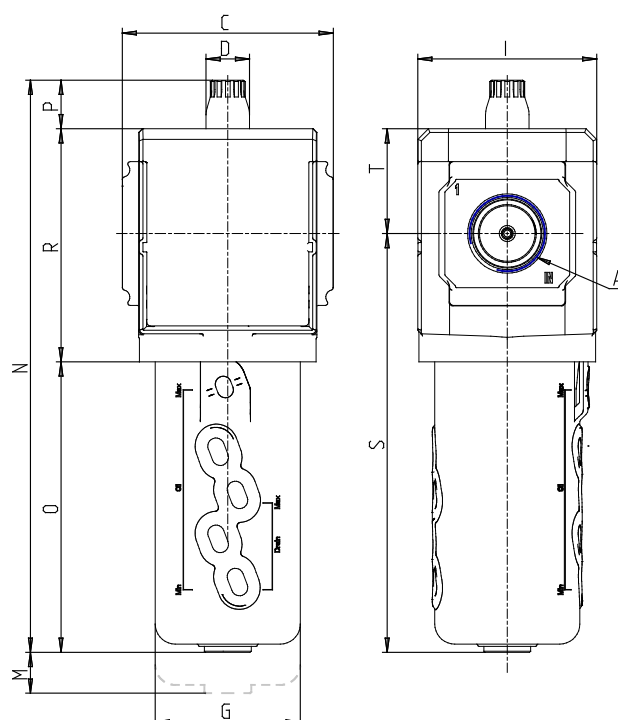

DIMENSIONS

A	G3/4
C (mm)	70.0
D (mm)	18.5
G (mm)	55.3
I (mm)	68
L	G 1/8
M (mm)	115
N (mm)	208.5
O (mm)	104.5
P (mm)	19.5
R (mm)	85
S (mm)	152
T (mm)	37.5
Weight (kg)	0.5