

Lubricators - Series MX

Product code: MX2-3/4-L00-LH

Datasheet creation date: 10/03/2025 01:27

Check the most updated document online [click here](#)



TECHNICAL DATA

Series	MX
Size	2
Ports (IN - OUT)	3/4 = G3/4
Lubricator	L
Design type	00 = atomized oil
Flow direction	LH = from right to left

Lubricators - Series MX

Product code: MX2-3/4-L00-LH

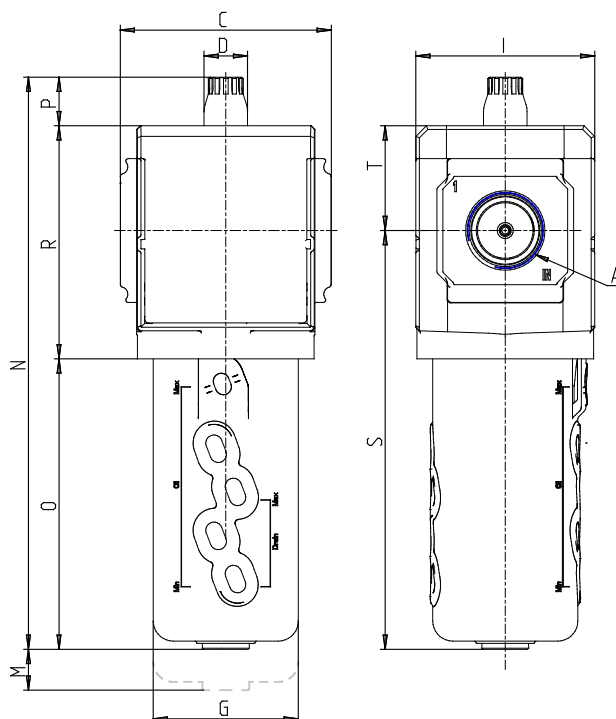

DIMENSIONS

A	G3/4
C (mm)	70.0
D (mm)	18.5
G (mm)	55.3
I (mm)	68
M (mm)	115
N (mm)	210
O (mm)	104.5
P (mm)	20.5
R (mm)	85
S (mm)	152
T (mm)	37.5
Weight (kg)	0.5