

Pressure regulators - Series MX

Product code: MX2-3/4-R400

Datasheet creation date: 10/03/2025 01:29

Check the most updated document online [click here](#)



TECHNICAL DATA

Series	MX
Size	2
PORTS (IN - OUT)	3/4 = G3/4
Type of regulator	R = pressure regulator
Operating pressure	4 = 0.5 ÷ 4 bar
Design type	0 = relieving (standard)
Pressure gauge	0 = without pressure gauge (with threaded port)
Flow direction	= from left to right (standard)

Pressure regulators - Series MX

Product code: MX2-3/4-R400

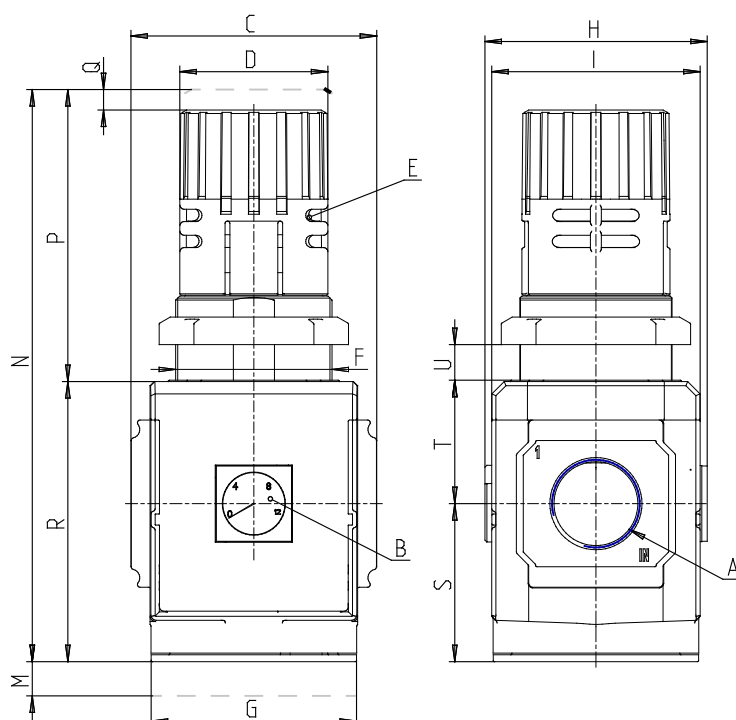

DIMENSIONS

A	G3/4
B (bar)	0-12 bar
C (mm)	70.0
D (mm)	45
F (mm)	M47x1.5
G (mm)	70
H (mm)	74.5
I (mm)	68
M (mm)	45
N (mm)	166
P (mm)	78
Q (mm)	5
R (mm)	88
S (mm)	50.5
T (mm)	37.5
U (mm)	0±13
Weight (kg)	0.6