

Pneumatic pilot operated pressure regulators - Series MX

Product code: MX2-3/4-RCP000

Datasheet creation date: 10/03/2025 01:27

Check the most updated document online [click here](#)



TECHNICAL DATA

Series	MX
Size	2
Ports (IN - OUT)	3/4 = G3/4
Type of regulator	R = pressure regulator
COMMAND	CP = pneumatic piloting
Working pressure	0 = 0.5 ÷ 10 bar
DESIGN TYPE	0 = relieving
Pressure gauge	0 = without manometer, threaded body
Flow direction	= from left to right (standard)

Pneumatic pilot operated pressure regulators - Series MX

Product code: MX2-3/4-RCP000

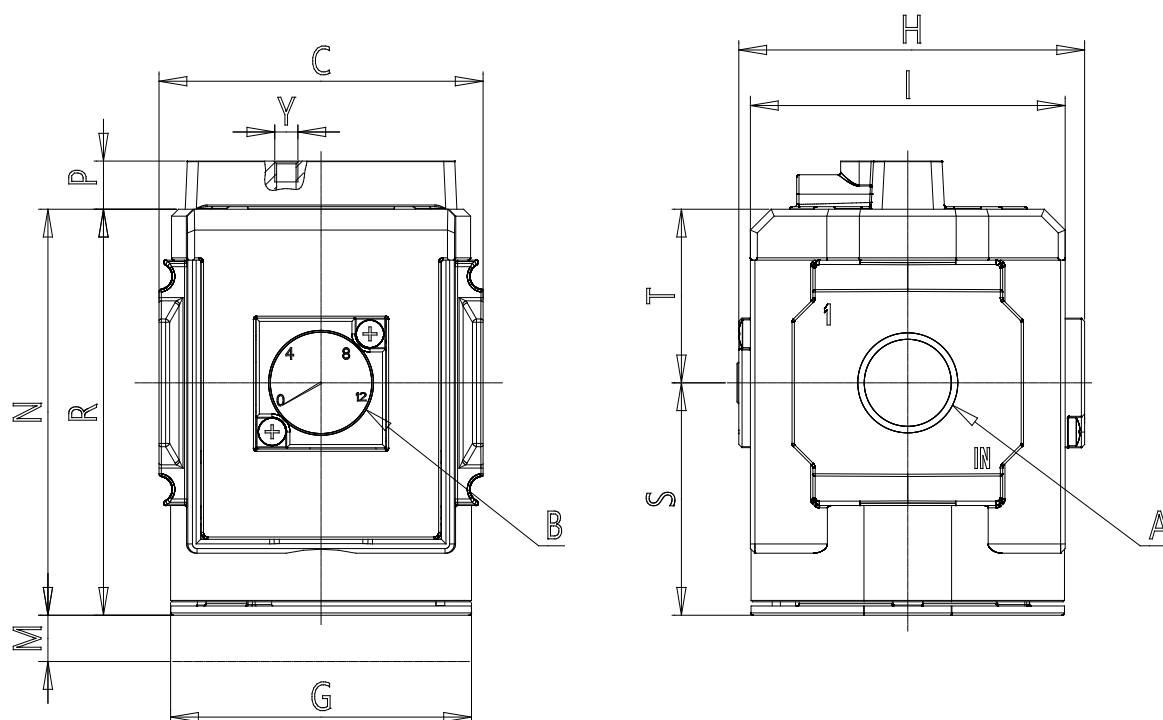

DIMENSIONS

A (mm)	G3/4
B (mm)	0 ÷ 12
C (mm)	70
G (mm)	65.0
H (mm)	74.5
I (mm)	68
M (mm)	45
Y (piloting) (mm)	M5
N (mm)	98
P (mm)	10
R (mm)	88
S (mm)	50.5
T (mm)	37.5
Weight (kg)	0.5