

Isolation 3/2-way valves - Series MX

Product code: MX2-3/4-V36

Datasheet creation date: 10/03/2025 01:31

Check the most updated document online [click here](#)



TECHNICAL DATA

Series	MX
Size	2
Ports (IN - OUT)	3/4 = G3/4
3/2-way valve	V
Design type	36 = pneumatic control
Flow direction	= from left to right (standard)

Isolation 3/2-way valves - Series MX

Product code: MX2-3/4-V36

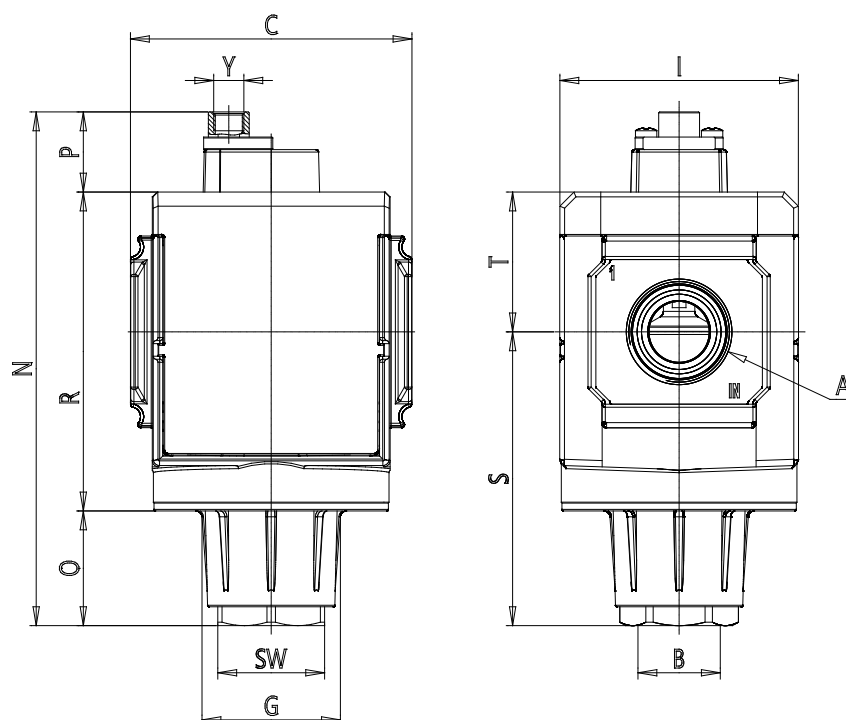

DIMENSIONS

	G3/4
(mm)	G 1/2
(mm)	70.0
(mm)	-
(mm)	34.5
(mm)	68
(mm)	-
(mm)	-
(mm)	122.0
(mm)	13
(mm)	21.0
(mm)	-
(mm)	88
(mm)	63.5
(mm)	27
(mm)	37.5
	-
Y (piloting)	G1/8
Weight (kg)	0.5