

Coalescing filters - Series MX

Product code: MX2-3/8-FC10

Datasheet creation date: 10/03/2025 01:17

Check the most updated document online [click here](#)



TECHNICAL DATA

Series	MX
Size	2
Ports (IN - OUT)	3/8 = G3/8
Coalescing filter	FC
Filtering element	1 = 1 µm
Draining of condensate	0 = semiautomatic-manual drain
Visual blockage indicator	= not present
Flow direction	= from left to right (standard)

Coalescing filters - Series MX

Product code: MX2-3/8-FC10

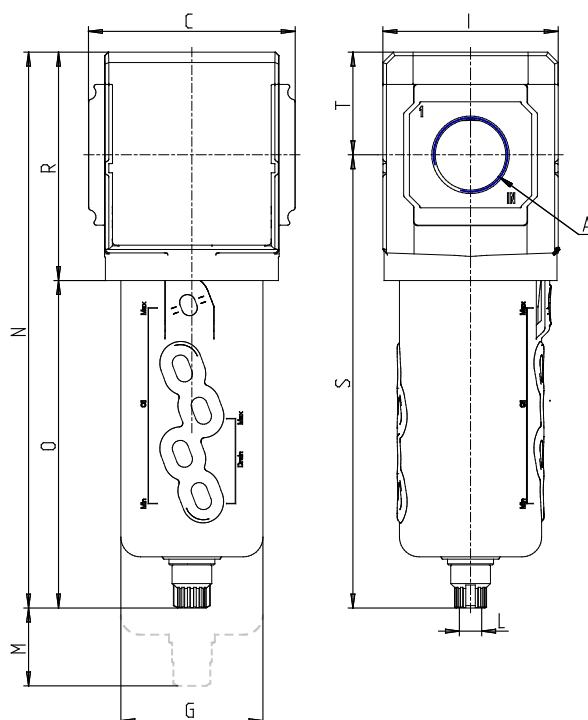

DIMENSIONS

A	G3/8
C (mm)	70.0
D (mm)	18.5
G (mm)	55.3
I (mm)	68
L	G 1/8
M (mm)	75
N (mm)	212
O (mm)	127
P (mm)	19.5
R (mm)	85
S (mm)	174.5
T (mm)	37.5
Weight (kg)	0.5