

Terminal flanges (IN/OUT) - Series MX

Product code: MX2-3/8-FL

Datasheet creation date: 07/03/2025 16:07

Check the most updated document online [click here](#)



■ TECHNICAL DATA

Mod.	MX2-3/8-FL
------	------------

Terminal flanges (IN/OUT) - Series MX

Product code: MX2-3/8-FL

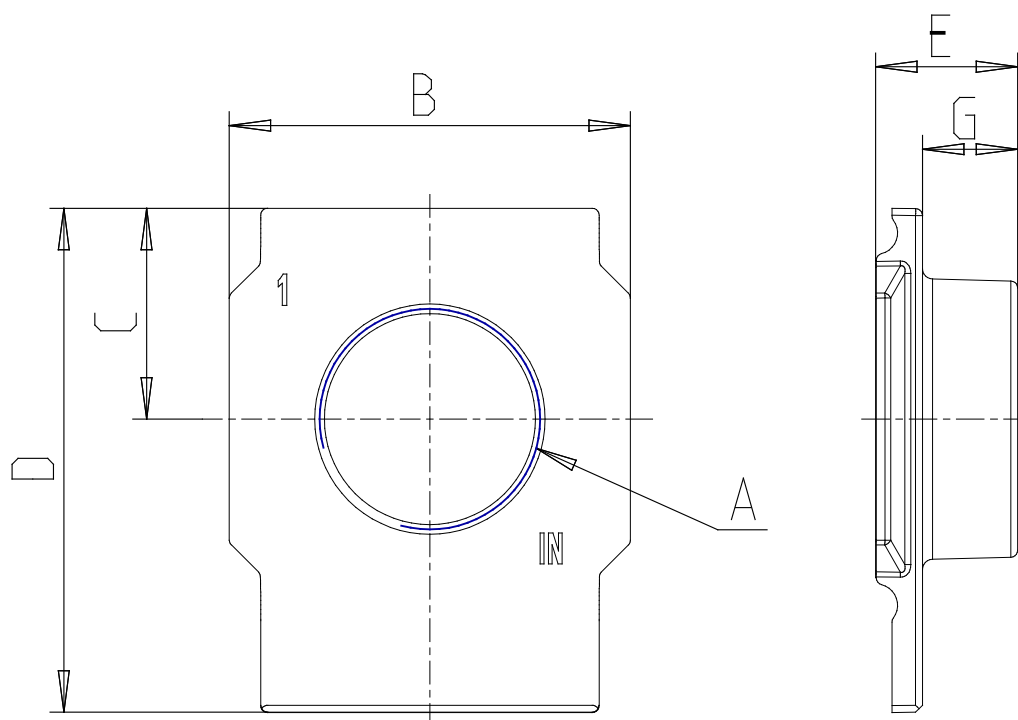

DIMENSIONS

A	G 3/8
B (mm)	50
C (mm)	26.5
D (mm)	63.5
E (mm)	17.0
G (mm)	11.0