

## Filters - Series MX

Product code: MX3-3/4-F131

Datasheet creation date: 10/03/2025 01:15

Check the most updated document online [click here](#)



### TECHNICAL DATA

<b>Series</b>	MX
<b>Size</b>	3
<b>Ports (IN - OUT)</b>	3/4 = G3/4
<b>Filter</b>	F
<b>Filtering element</b>	1 = 5 µm
<b>Draining of condensate</b>	3 = automatic drain
<b>Visual blockage indicator</b>	1 = present
<b>Flow direction</b>	= from left to right (standard)

## Filters - Series MX

Product code: MX3-3/4-F131

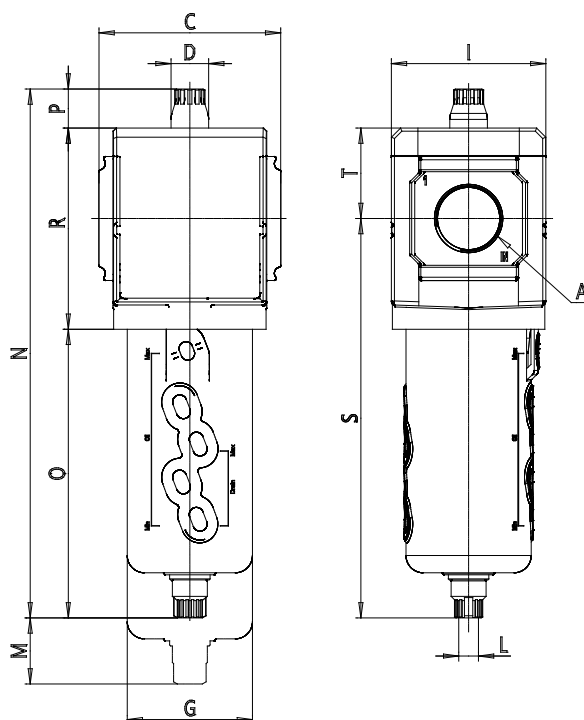

### DIMENSIONS

<b>A</b>	G3/4
<b>C (mm)</b>	89.5
<b>D (mm)</b>	18.5
<b>G (mm)</b>	61.5
<b>I (mm)</b>	76
<b>L</b>	G 1/8
<b>M (mm)</b>	95
<b>N (mm)</b>	260.0
<b>O (mm)</b>	142.0
<b>P (mm)</b>	19.5
<b>R (mm)</b>	99
<b>S (mm)</b>	196.5
<b>T (mm)</b>	44.5
<b>Weight (kg)</b>	0.8