

Activated carbon filters - Series MX

Product code: MX3-3/4-FCA1

Datasheet creation date: 10/03/2025 01:18

Check the most updated document online [click here](#)



TECHNICAL DATA

Series	MX
Size	3
Ports (IN - OUT)	3/4 = G3/4
Activated carbon filter	FCA
Visual blockage indicator	1 = present
Flow direction	= from left to right (standard)

Activated carbon filters - Series MX

Product code: MX3-3/4-FCA1

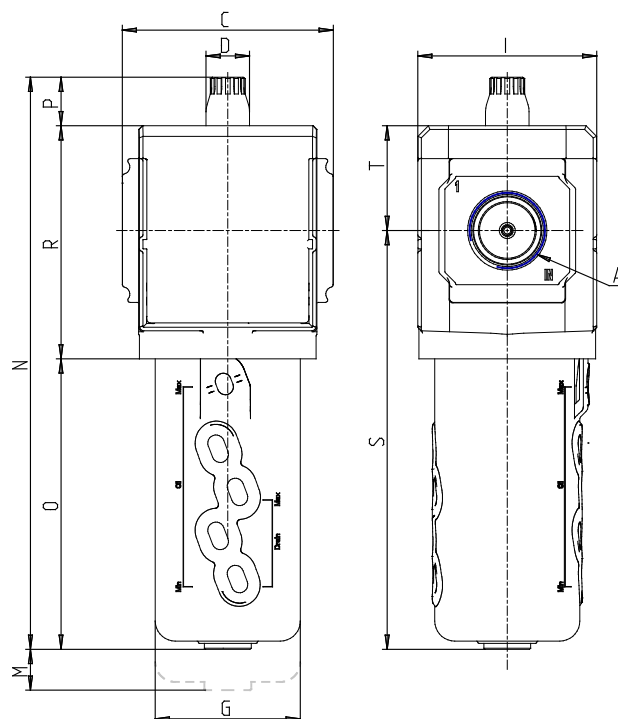

DIMENSIONS

A	G3/4
C (mm)	89.5
D (mm)	18.5
G (mm)	61.5
I (mm)	76
L	G 1/8
M (mm)	130
N (mm)	241.0
O (mm)	123.0
P (mm)	19.5
R (mm)	99
S (mm)	0
T (mm)	44.5
Weight (kg)	0.8