

Lubricators - Series MX

Product code: MX3-3/4-L00-LH

Datasheet creation date: 10/03/2025 01:27

Check the most updated document online [click here](#)



TECHNICAL DATA

Series	MX
Size	3
Ports (IN - OUT)	3/4 = G3/4
Lubricator	L
Design type	00 = atomized oil
Flow direction	LH = from right to left

Lubricators - Series MX

Product code: MX3-3/4-L00-LH

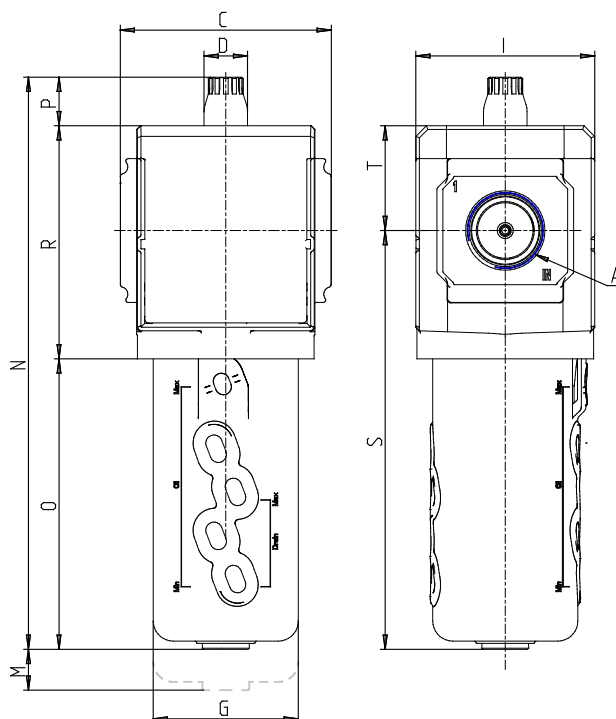

DIMENSIONS

A	G3/4
C (mm)	89.5
D (mm)	18.5
G (mm)	61.5
I (mm)	76
M (mm)	130
N (mm)	243
O (mm)	123.0
P (mm)	21.0
R (mm)	99
S (mm)	178
T (mm)	44.5
Weight (kg)	0.8