

## Filter-pressure regulator Series N - Serie N

Product code: N104-D01

Datasheet creation date: 10/03/2025 01:45

Check the most updated document online [click here](#)



### TECHNICAL DATA

Mod.	N104-D01
R (mm)	3

## Filter-pressure regulator Series N - Serie N

Product code: N104-D01

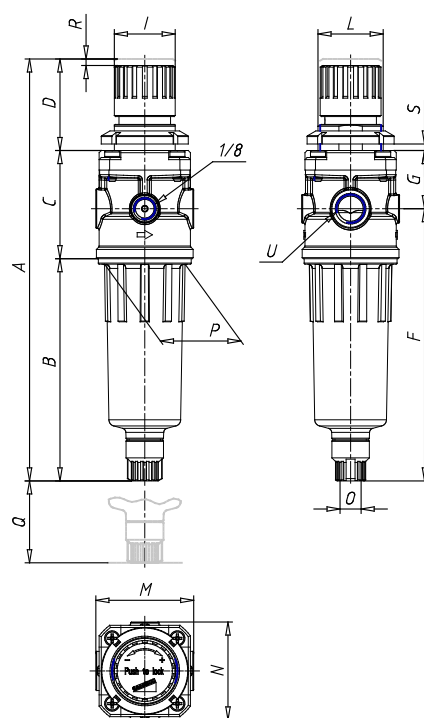

### DIMENSIONS

<b>A (mm)</b>	167
<b>B (mm)</b>	78
<b>C (mm)</b>	50
<b>D (mm)</b>	39
<b>F (mm)</b>	101
<b>G (mm)</b>	27
<b>I (mm)</b>	28
<b>L</b>	30x1.5
<b>M (mm)</b>	45
<b>N (mm)</b>	45
<b>O</b>	G1/8
<b>P (mm)</b>	38
<b>Q (mm)</b>	40
<b>U</b>	G1/4