

Filter-pressure regulator Series N - Serie N

Product code: N104-D11

Datasheet creation date: 10/03/2025 01:45

Check the most updated document online [click here](#)



TECHNICAL DATA

Mod.	N104-D11
R (mm)	3

Filter-pressure regulator Series N - Serie N

Product code: N104-D11

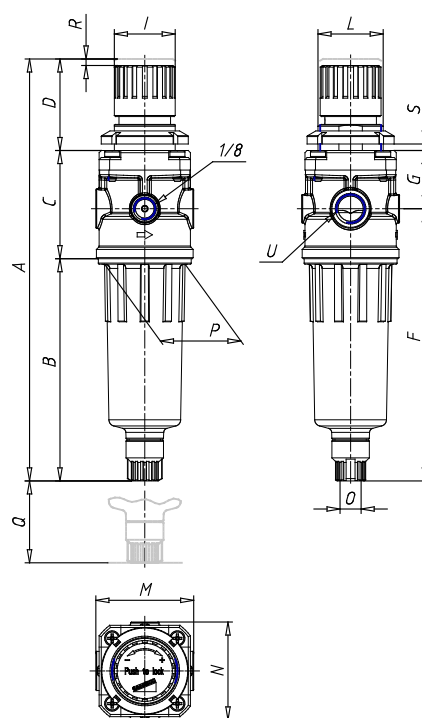

DIMENSIONS

A (mm)	167
B (mm)	78
C (mm)	50
D (mm)	39
F (mm)	101
G (mm)	27
I (mm)	28
L	30x1.5
M (mm)	45
N (mm)	45
O	G1/8
P (mm)	38
Q (mm)	40
U	G1/4