

Filter and coalescing filter - Series N

Product code: N108-F08

Datasheet creation date: 10/03/2025 01:44

Check the most updated document online [click here](#)



TECHNICAL DATA

Mod.	N108-F08
------	----------

Filter and coalescing filter - Series N

Product code: N108-F08

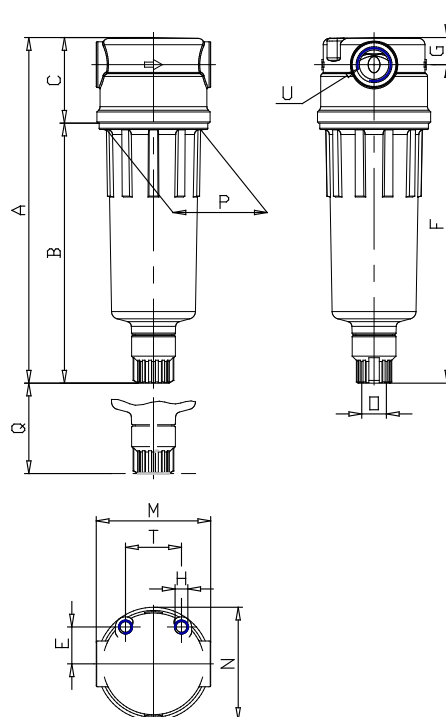

DIMENSIONS

A (mm)	111
B (mm)	78
C (mm)	33
E (mm)	14.5
F (mm)	101
G (mm)	10
H	M5
M (mm)	45
N (mm)	44.5
O	G1/8
P (mm)	38
Q (mm)	40
T (mm)	22
U	G1/8