

## Pressure regulator - Series N

Product code: N1204-R71

Datasheet creation date: 10/03/2025 01:48

Check the most updated document online [click here](#)



### TECHNICAL DATA

Mod.	N1204-R71
R (mm)	3
U	G1/4

## Pressure regulator - Series N

Product code: N1204-R71

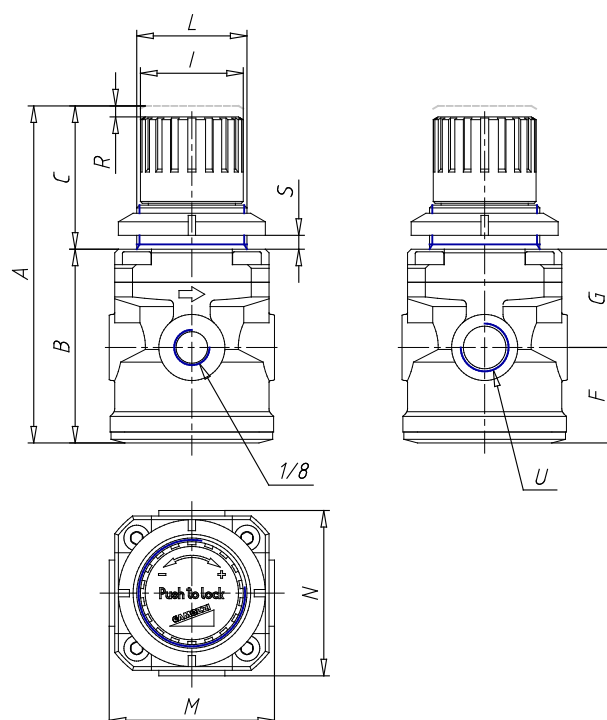

### DIMENSIONS

<b>A (mm)</b>	92
<b>B (mm)</b>	53
<b>C (mm)</b>	39
<b>F (mm)</b>	26
<b>G (mm)</b>	27
<b>I (mm)</b>	28
<b>L (mm)</b>	30x1.5
<b>M (mm)</b>	45
<b>N (mm)</b>	45