

Pressure regulator - Series N

Product code: N1208-R20

Datasheet creation date: 10/03/2025 01:48

Check the most updated document online [click here](#)



TECHNICAL DATA

Mod.	N1208-R20
R (mm)	3
U	G1/8

Pressure regulator - Series N

Product code: N1208-R20

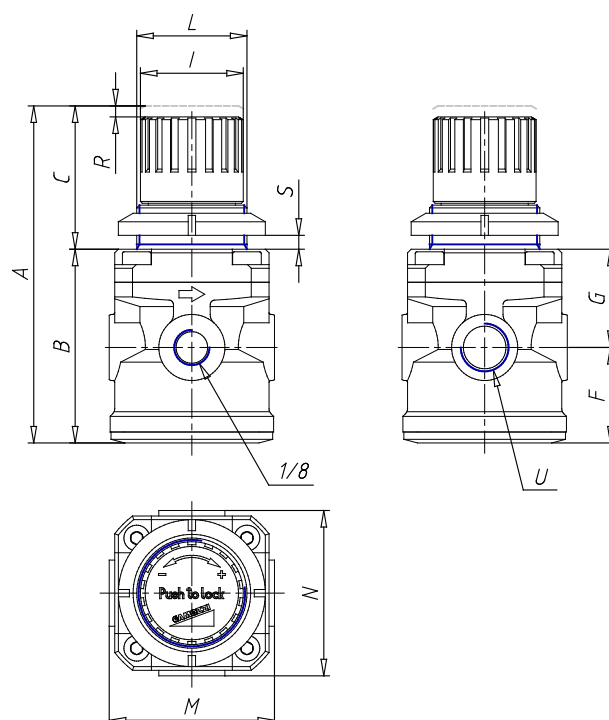

DIMENSIONS

A (mm)	92
B (mm)	53
C (mm)	39
F (mm)	26
G (mm)	27
I (mm)	28
L (mm)	30x1.5
M (mm)	45
N (mm)	45