

## Filter-pressure regulator Series N - Serie N

Product code: N204-D05-4

Datasheet creation date: 10/03/2025 01:46

Check the most updated document online [click here](#)



### TECHNICAL DATA

|        |            |
|--------|------------|
| Mod.   | N204-D05-4 |
| R (mm) | 3          |

## Filter-pressure regulator Series N - Serie N

Product code: N204-D05-4

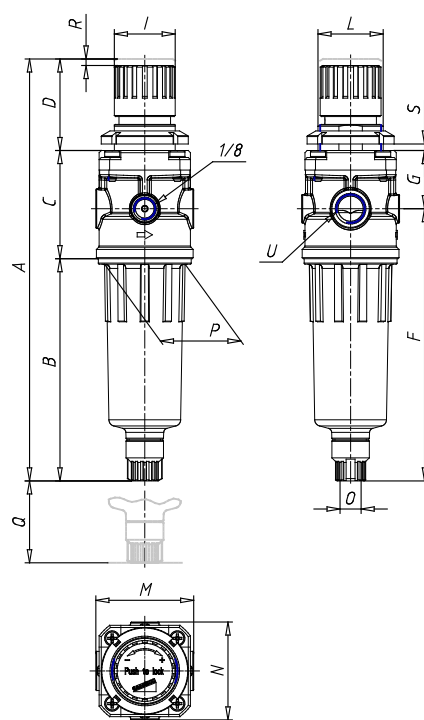

### DIMENSIONS

|               |        |
|---------------|--------|
| <b>A (mm)</b> | 191    |
| <b>B (mm)</b> | 102    |
| <b>C (mm)</b> | 50     |
| <b>D (mm)</b> | 39     |
| <b>F (mm)</b> | 125    |
| <b>G (mm)</b> | 27     |
| <b>I (mm)</b> | 28     |
| <b>L</b>      | 30x1.5 |
| <b>M (mm)</b> | 45     |
| <b>N (mm)</b> | 45     |
| <b>O</b>      | G1/8   |
| <b>P (mm)</b> | 38     |
| <b>Q (mm)</b> | 40     |
| <b>U</b>      | G1/4   |