

Filter-pressure regulator Series N - Serie N

Product code: N204-D08-2

Datasheet creation date: 10/03/2025 01:46

Check the most updated document online [click here](#)



TECHNICAL DATA

Mod.	N204-D08-2
R (mm)	3

Filter-pressure regulator Series N - Serie N

Product code: N204-D08-2

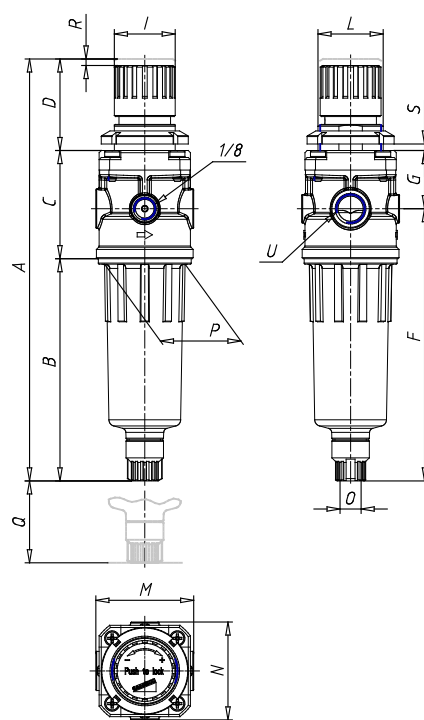

DIMENSIONS

A (mm)	191
B (mm)	102
C (mm)	50
D (mm)	39
F (mm)	125
G (mm)	27
I (mm)	28
L	30x1.5
M (mm)	45
N (mm)	45
O	G1/8
P (mm)	38
Q (mm)	40
U	G1/4