

Filter-pressure regulator Series N - Serie N

Product code: N208-D05-7

Datasheet creation date: 10/03/2025 01:47

Check the most updated document online [click here](#)



TECHNICAL DATA

| | |
|--------|------------|
| Mod. | N208-D05-7 |
| R (mm) | 3 |

Filter-pressure regulator Series N - Serie N

Product code: N208-D05-7

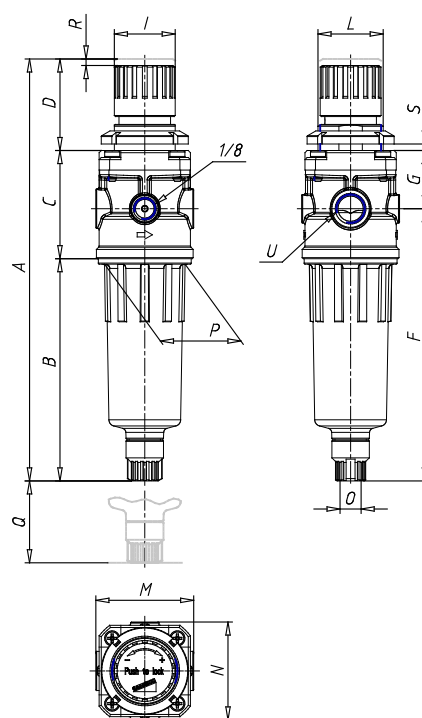

DIMENSIONS

| | |
|---------------|--------|
| A (mm) | 191 |
| B (mm) | 102 |
| C (mm) | 50 |
| D (mm) | 39 |
| F (mm) | 125 |
| G (mm) | 27 |
| I (mm) | 28 |
| L | 30x1.5 |
| M (mm) | 45 |
| N (mm) | 45 |
| O | G1/8 |
| P (mm) | 38 |
| Q (mm) | 40 |
| U | G1/8 |