

3/2-way solenoid valve - Series NA

Product code: NA44N-15-02

Datasheet creation date: 10/03/2025 12:05

Check the most updated document online [click here](#)



■ TECHNICAL DATA

Mod.	NA44N-15-02
------	-------------

3/2-way solenoid valve - Series NA

Product code: NA44N-15-02

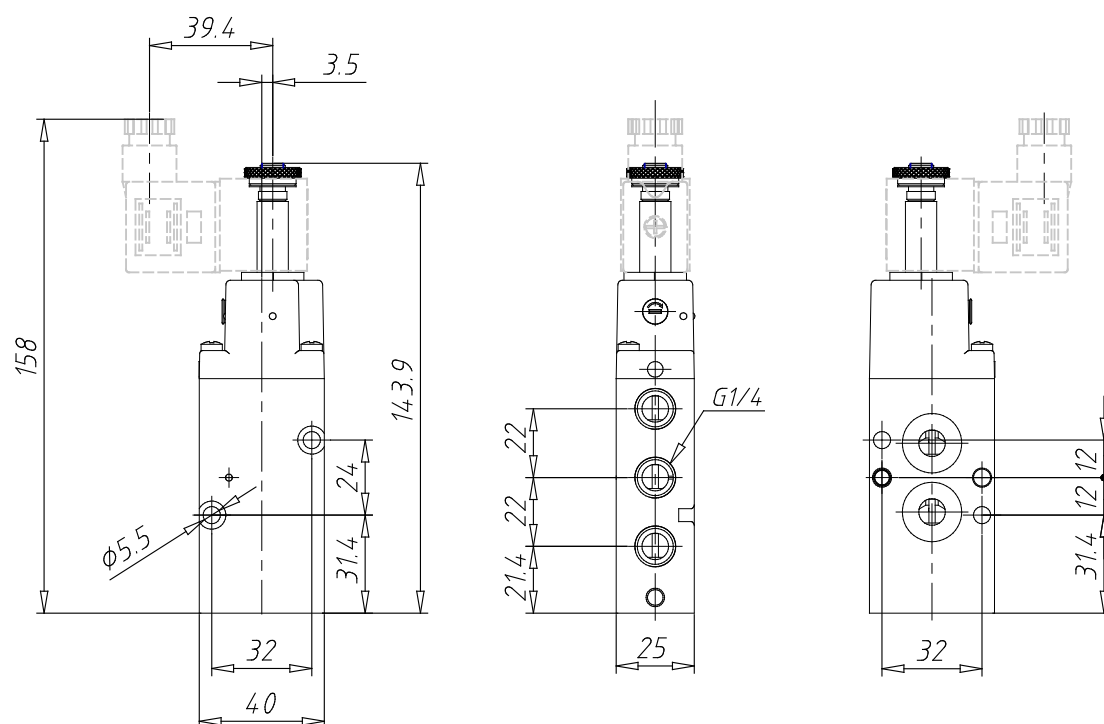

DIMENSIONS

Mod.	NA44N-15-02
------	-------------