

Mod. ND6430 - Series ND6000 inch fittings

Product code: ND6430 04-02

Datasheet creation date: 10/03/2025 09:22

Check the most updated document online [click here](#)



■ TECHNICAL DATA

Ident number	ND6430 04-02
--------------	--------------

Mod. ND6430 - Series ND6000 inch fittings

Product code: ND6430 04-02

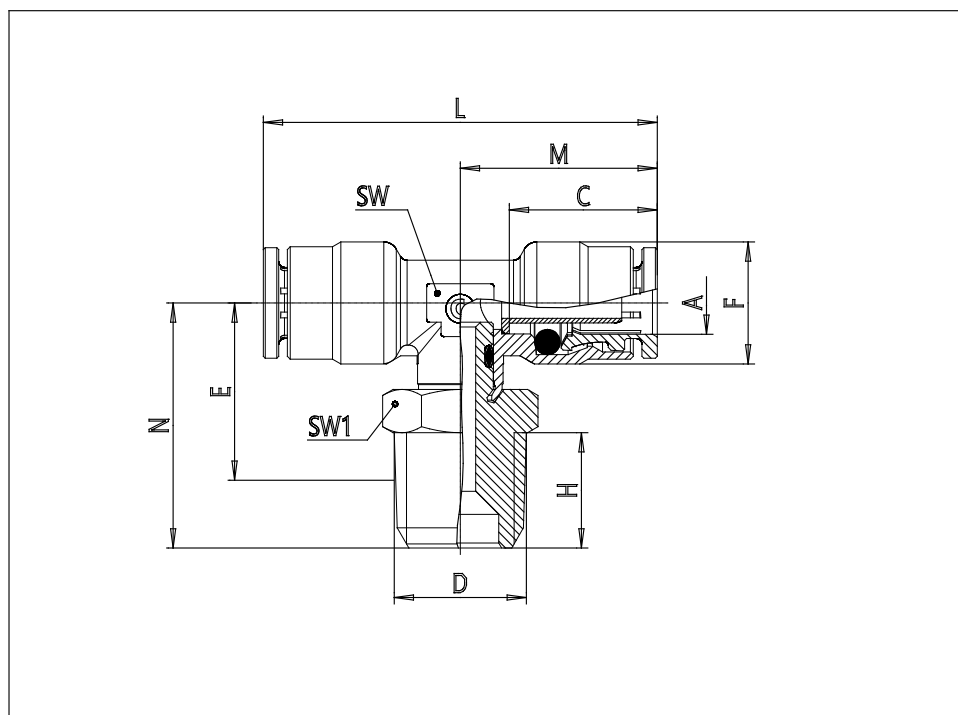

DIMENSIONS

A (INCH)	1/4
NPTF (INCH)	1/8
C (INCH)	0.606
F (INCH)	0.500
E (INCH)	0.669
H (INCH)	0.315
M (INCH)	0.807
L (INCH)	1.614
N (INCH)	0.846
SW (INCH)	0.354
SW1 (INCH)	0.472