

Mod. ND6430 - Series ND6000 inch fittings

Product code: ND6430 08-08

Datasheet creation date: 10/03/2025 09:22

Check the most updated document online [click here](#)



■ TECHNICAL DATA

Ident number	ND6430 08-08
--------------	--------------

Mod. ND6430 - Series ND6000 inch fittings

Product code: ND6430 08-08

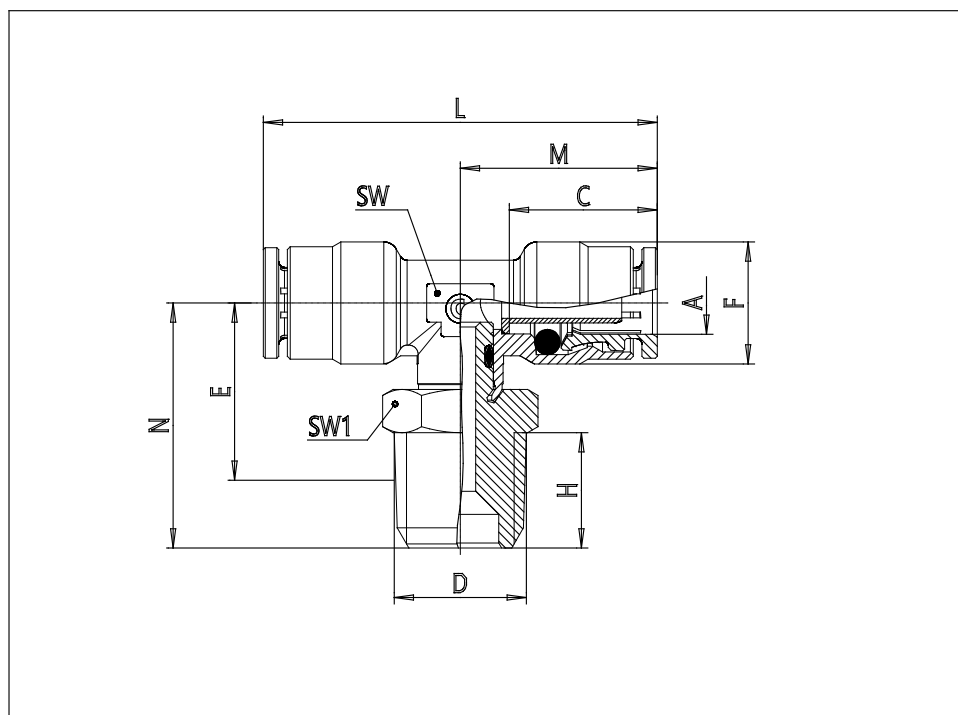

DIMENSIONS

A (INCH)	1/2
NPTF (INCH)	1/2
C (INCH)	0.787
F (INCH)	0.768
E (INCH)	0.925
H (INCH)	0.610
M (INCH)	1.102
L (INCH)	2.205
N (INCH)	1.339
SW (INCH)	0.591
SW1 (INCH)	0.866