

Mod. ND6440 - Series ND6000 inch fittings

Product code: ND6440 08-06

Datasheet creation date: 10/03/2025 09:22

Check the most updated document online [click here](#)



■ TECHNICAL DATA

Ident number	ND6440 08-06
--------------	--------------

Mod. ND6440 - Series ND6000 inch fittings

Product code: ND6440 08-06

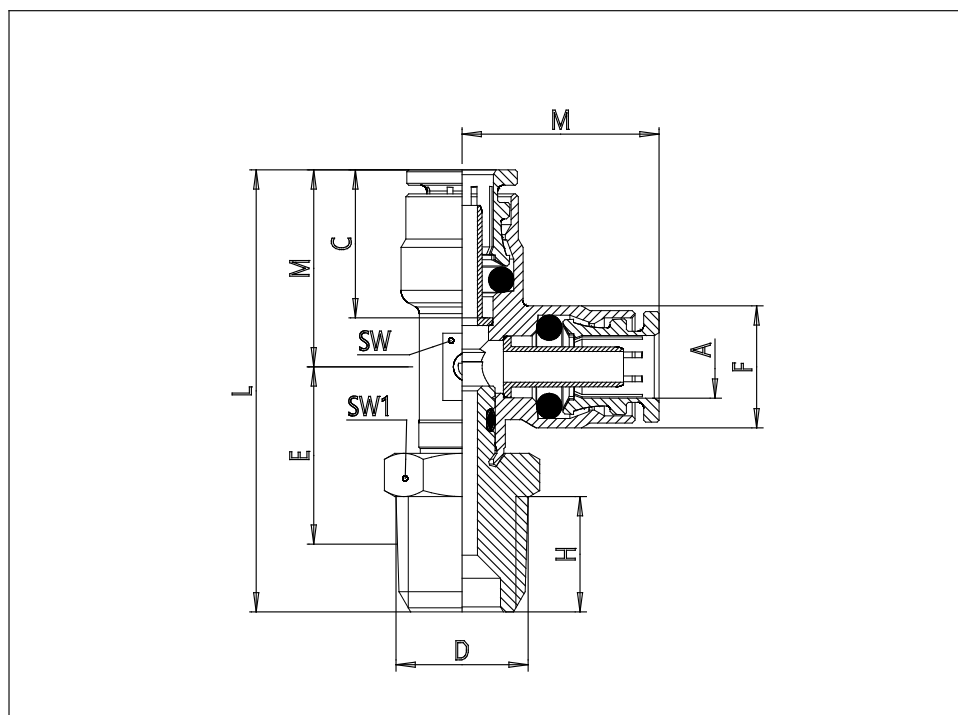

DIMENSIONS

A (INCH)	1/2
NPTF (INCH)	3/8
C (INCH)	0.787
F (INCH)	0.768
E (INCH)	0.846
H (INCH)	0.472
M (INCH)	1.102
L (INCH)	2.283
SW (INCH)	0.591
SW1 (INCH)	0.748