

Mod. ND6510 - Series ND6000 inch fittings

Product code: ND6510 04-04

Datasheet creation date: 10/03/2025 09:23

Check the most updated document online [click here](#)



■ TECHNICAL DATA

Ident number	ND6510 04-04
--------------	--------------

Mod. ND6510 - Series ND6000 inch fittings

Product code: ND6510 04-04

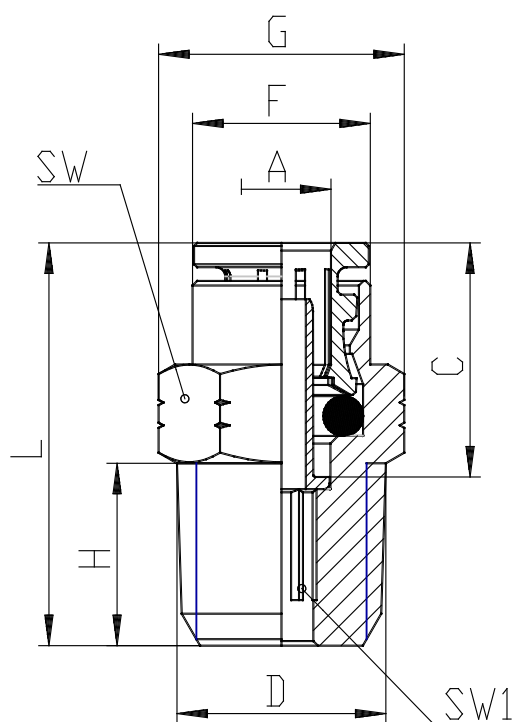

DIMENSIONS

A (INCH)	1/4
NPTF (INCH)	1/4
C (INCH)	0.606
F (INCH)	0.461
G (INCH)	0.638
H (INCH)	0.472
I (INCH)	0.165
L (INCH)	1.043
SW (INCH)	0.551
SW1 (INCH)	0.157