

Mod. ND6510 - Series ND6000 inch fittings

Product code: ND6510 06-02

Datasheet creation date: 10/03/2025 09:23

Check the most updated document online [click here](#)



TECHNICAL DATA

Ident number	ND6510 06-02
--------------	--------------

Mod. ND6510 - Series ND6000 inch fittings

Product code: ND6510 06-02

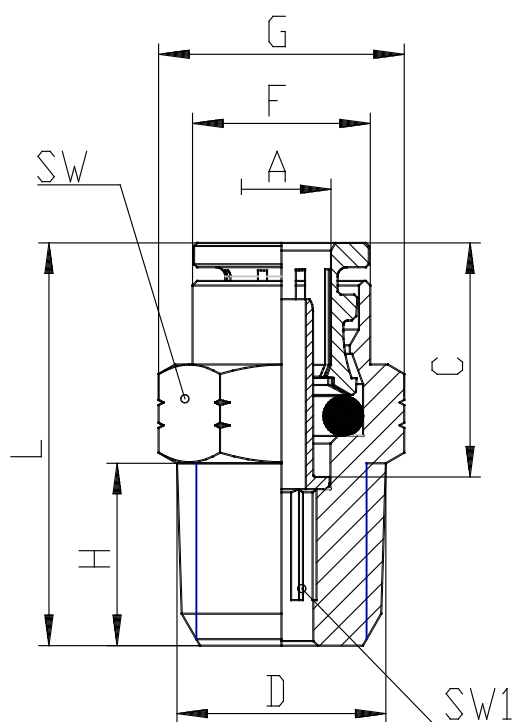

DIMENSIONS

A (INCH)	3/8
NPTF (INCH)	1/8
C (INCH)	0.787
F (INCH)	0.606
G (INCH)	0.776
H (INCH)	0.315
I (INCH)	0.244
L (INCH)	1.201
SW (INCH)	0.669
SW1 (INCH)	0.197