

Mod. ND6510 - Series ND6000 inch fittings

Product code: ND6510 08-04

Datasheet creation date: 10/03/2025 09:23

Check the most updated document online [click here](#)



TECHNICAL DATA

Ident number	ND6510 08-04
--------------	--------------

Mod. ND6510 - Series ND6000 inch fittings

Product code: ND6510 08-04

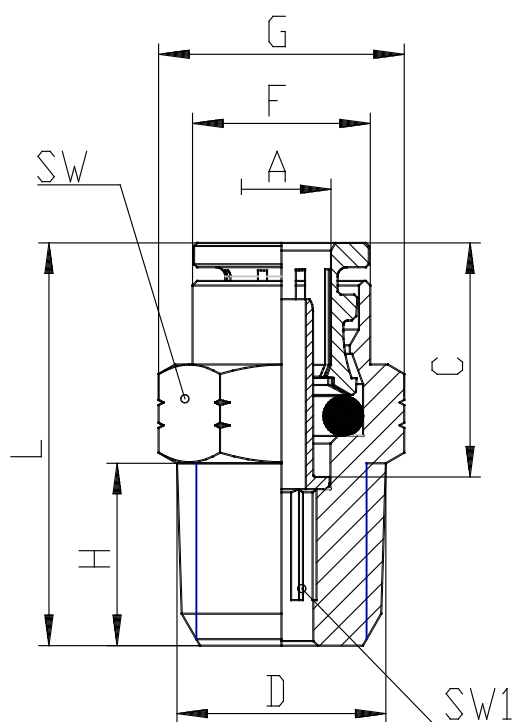

DIMENSIONS

A (INCH)	1/2
NPTF (INCH)	1/4
C (INCH)	0.787
F (INCH)	0.736
G (INCH)	0.866
H (INCH)	0.472
I (INCH)	0.362
L (INCH)	1.358
SW (INCH)	0.748
SW1 (INCH)	0.276