

Mod. ND6520 - Series ND6000 inch fittings

Product code: ND6520 06-08

Datasheet creation date: 10/03/2025 09:23

Check the most updated document online [click here](#)



TECHNICAL DATA

Ident number	ND6520 06-08
--------------	--------------

Mod. ND6520 - Series ND6000 inch fittings

Product code: ND6520 06-08

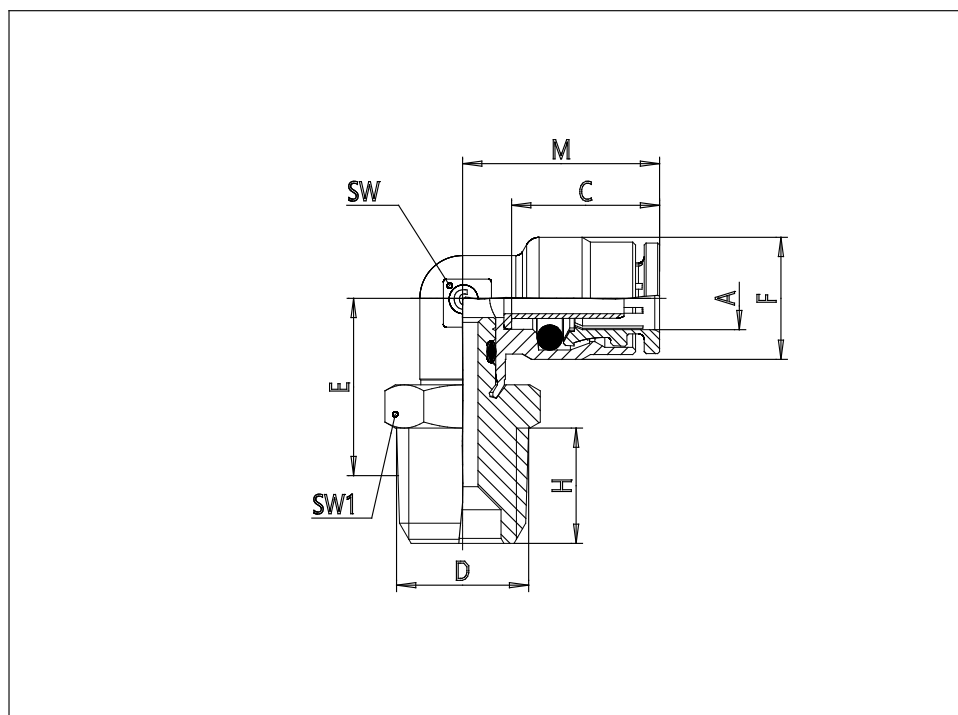

DIMENSIONS

A (INCH)	3/8
NPTF (INCH)	1/2
C (INCH)	0.787
F (INCH)	0.768
H (INCH)	0.610
M (INCH)	1.043
SW (INCH)	0.512
SW1 (INCH)	0.866