

Mod. ND6520 - Series ND6000 inch fittings

Product code: ND6520 08-04

Datasheet creation date: 10/03/2025 09:23

Check the most updated document online [click here](#)



TECHNICAL DATA

Ident number	ND6520 08-04
--------------	--------------

Mod. ND6520 - Series ND6000 inch fittings

Product code: ND6520 08-04

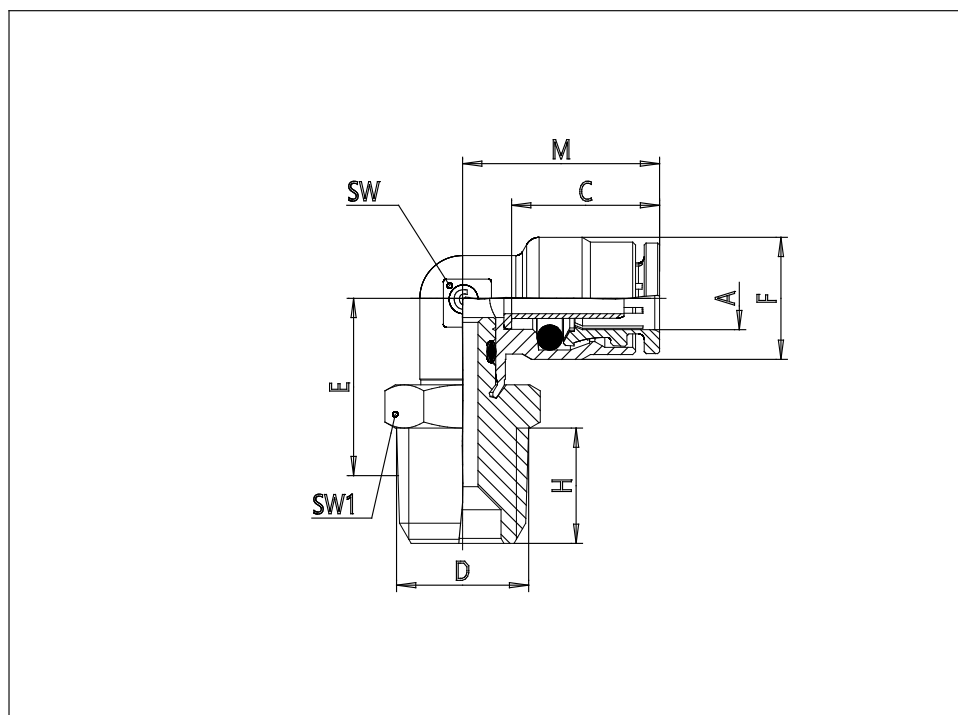

DIMENSIONS

A (INCH)	1/2
NPTF (INCH)	1/4
C (INCH)	0.787
F (INCH)	0.768
H (INCH)	0.472
M (INCH)	1.102
SW (INCH)	0.591
SW1 (INCH)	0.669