

Foot mount/flange - Mod. P

Product code: P-42-50

Datasheet creation date: 07/03/2025 15:59

Check the most updated document online [click here](#)



■ TECHNICAL DATA

Mod.	P-42-50
------	---------

Foot mount/flange - Mod. P

Product code: P-42-50

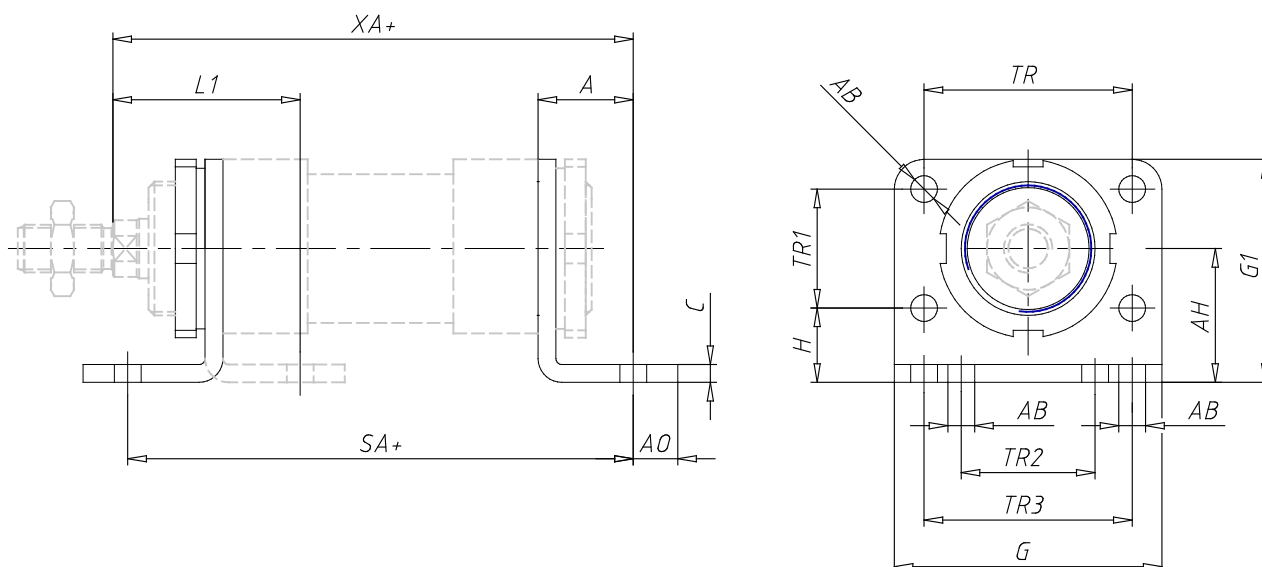

DIMENSIONS

L1 (mm)	63
SA (mm)	170
XA (mm)	175
A (mm)	32
AB (mm)	9
AO (mm)	15
AH (mm)	45
C (mm)	6
G (mm)	90
G1 (mm)	75
TR (mm)	70
TR1 (mm)	40
TR2 (mm)	45
TR3 (mm)	70
H (mm)	25