

Foot mount/flange - Mod. P

Product code: P-42-63

Datasheet creation date: 07/03/2025 15:59

Check the most updated document online [click here](#)



TECHNICAL DATA

Mod.	P-42-63
------	---------

Foot mount/flange - Mod. P

Product code: P-42-63

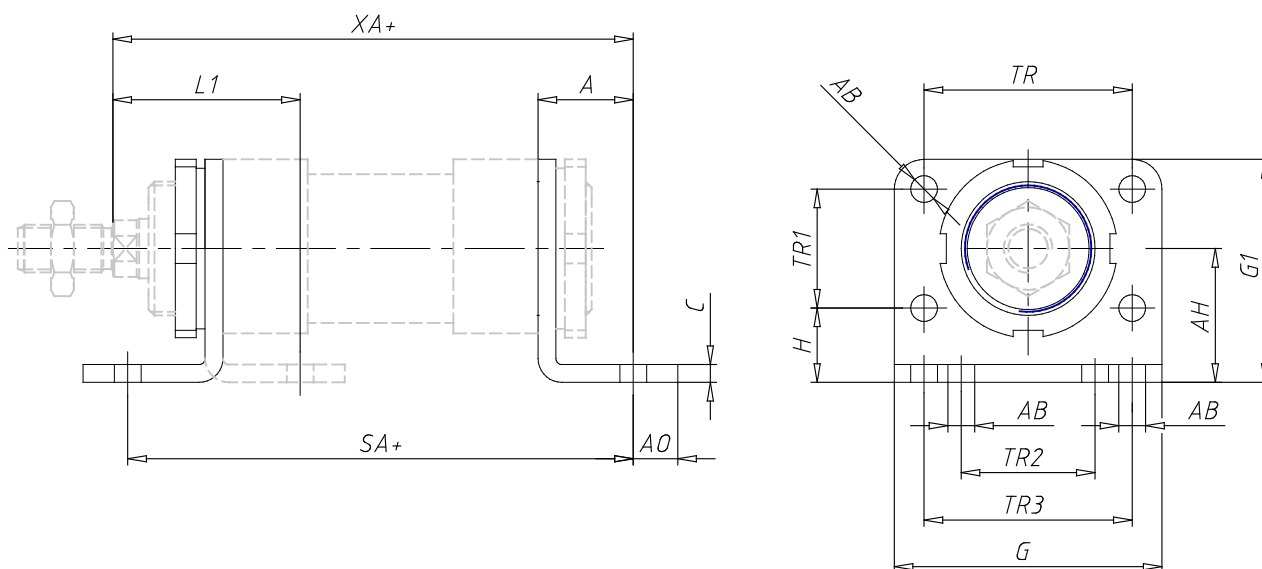

DIMENSIONS

L1 (mm)	63
SA (mm)	185
XA (mm)	190
A (mm)	32
AB (mm)	9
AO (mm)	10
AH (mm)	50
C (mm)	6
G (mm)	96
G1 (mm)	85
TR (mm)	76
TR1 (mm)	50
TR2 (mm)	50
TR3 (mm)	76
H (mm)	25