

## Pusher kit - Mod. P-CGZT

Product code: P-CGZT-040

Datasheet creation date: 07/03/2025 16:10

Check the most updated document online [click here](#)



### TECHNICAL DATA

Mod. (mm)	P-CGZT-040
-----------	------------

## Pusher kit - Mod. P-CGZT

Product code: P-CGZT-040

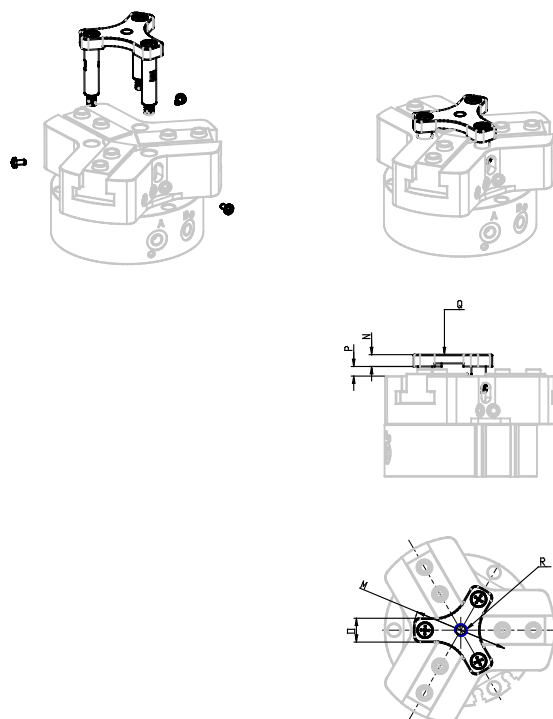

### DIMENSIONS

<b>M (mm)</b>	24.0
<b>N (mm)</b>	3.5
<b>O (mm)</b>	6.0
<b>P (mm)</b>	2.5
<b>Q (mm)</b>	10N
<b>R</b>	M3