

Pusher kit - Mod. P-CGZT

Product code: P-CGZT-050

Datasheet creation date: 07/03/2025 16:10

Check the most updated document online [click here](#)



TECHNICAL DATA

Mod. (mm)	P-CGZT-050
-----------	------------

Pusher kit - Mod. P-CGZT

Product code: P-CGZT-050

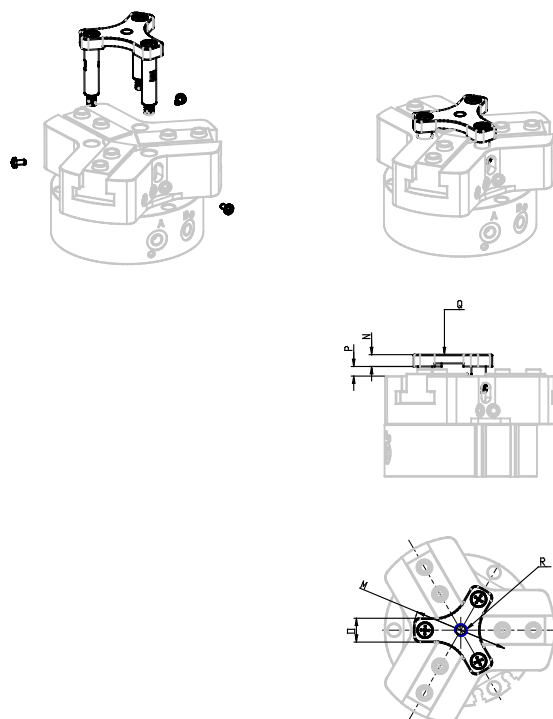

DIMENSIONS

M (mm)	32.5
N (mm)	4.5
O (mm)	8.0
P (mm)	3.0
Q (mm)	14N
R	M4