

Pusher kit - Mod. P-CGZT

Product code: P-CGZT-080

Datasheet creation date: 07/03/2025 16:10

Check the most updated document online [click here](#)



TECHNICAL DATA

Mod. (mm)	P-CGZT-080
-----------	------------

Pusher kit - Mod. P-CGZT

Product code: P-CGZT-080

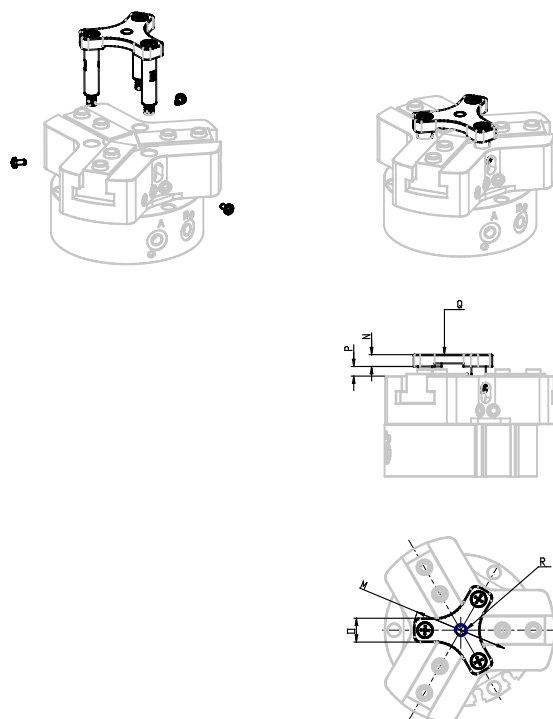

DIMENSIONS

M (mm)	49.0
N (mm)	6.0
O (mm)	12.5
P (mm)	5.0
Q (mm)	32N
R	M6