

## Pusher kit - Mod. P-CGZT

Product code: P-CGZT-100

Datasheet creation date: 07/03/2025 16:10

Check the most updated document online [click here](#)



### TECHNICAL DATA

Mod. (mm)	P-CGZT-100
-----------	------------

## Pusher kit - Mod. P-CGZT

Product code: P-CGZT-100

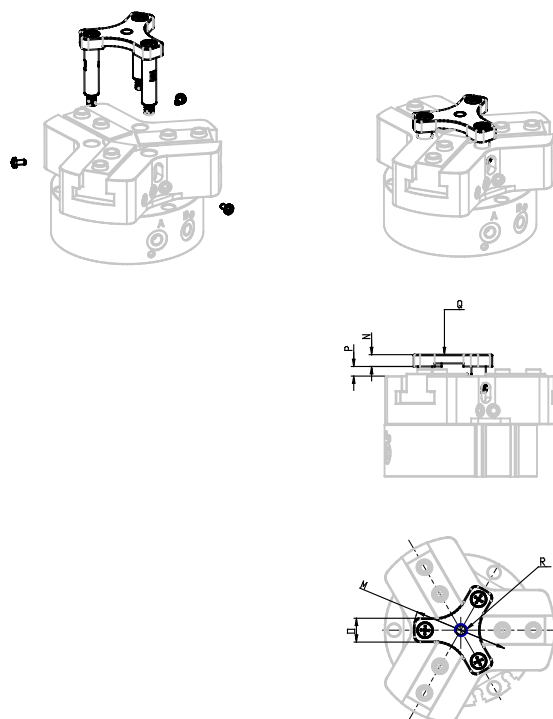

### DIMENSIONS

<b>M (mm)</b>	59.0
<b>N (mm)</b>	7.0
<b>O (mm)</b>	14.0
<b>P (mm)</b>	5.0
<b>Q (mm)</b>	48N
<b>R</b>	M8