

Elettrovalvole a comando diretto - Serie P

Product code: P000-305-P56

Datasheet creation date: 10/03/2025 11:38

Check the most updated document online [click here](#)



TECHNICAL DATA

Series	P
Body execution	0 = interface
Number of seats	00 = ISO 15218 interface
Number of ways - Functions	3 = 3/2 way - NC
Valve connections	0 = ISO 15218 interface
Orifice diameter	5 = Ø 1.1 mm
Materials	P = PBT body - NBR - FKM - PU seals
Electrical connection	5 = industrial standard (9.4 mm)
Voltage - Absorbed power	6 = 110 V DC - 2W
Fixing	= fixing screws for metal
Options	= Standard

Elettrovalvole a comando diretto - Serie P

Product code: P000-305-P56

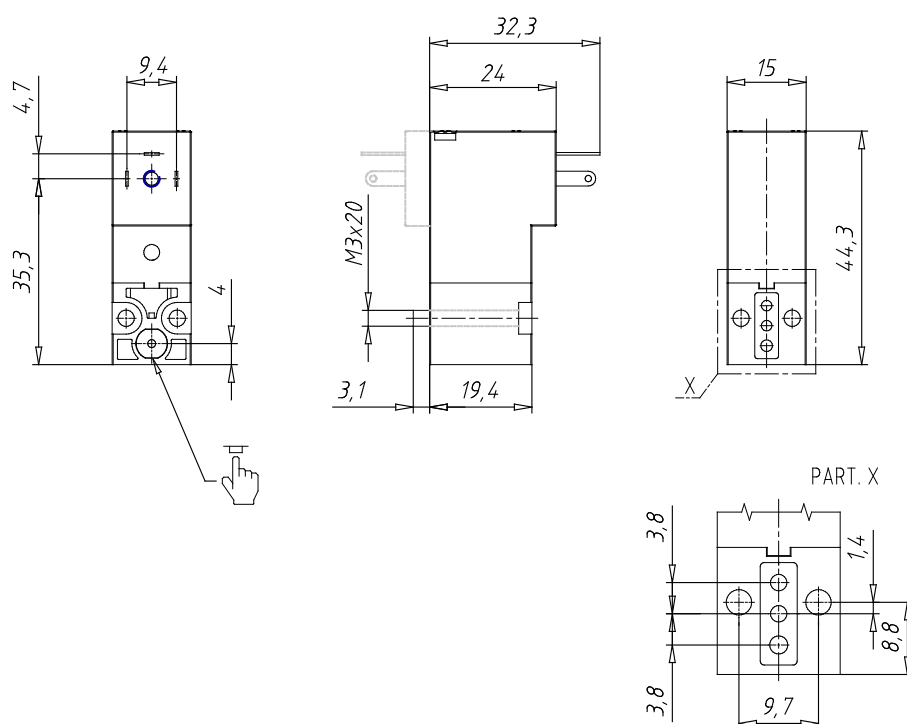

DIMENSIONS

Series	P
Body execution	0 = interface
Number of seats	00 = ISO 15218 interface
Number of ways - Functions	3 = 3/2 way - NC
Valve connections	0 = ISO 15218 interface
Orifice diameter	5 = \varnothing 1.1 mm
Materials	P = PBT body - NBR - FKM - PU seals
Electrical connection	5 = industrial standard (9.4 mm)
Voltage - Absorbed power	6 = 110 V DC - 2W
Fixing	= fixing screws for metal
Options	= Standard