

Mod. P6520 - Fittings Serie 6000 inch

Product code: P6520 02-02

Datasheet creation date: 10/03/2025 10:30

Check the most updated document online [click here](#)



TECHNICAL DATA

Mod.	P6520 02-02
------	-------------

Mod. P6520 - Fittings Serie 6000 inch

Product code: P6520 02-02

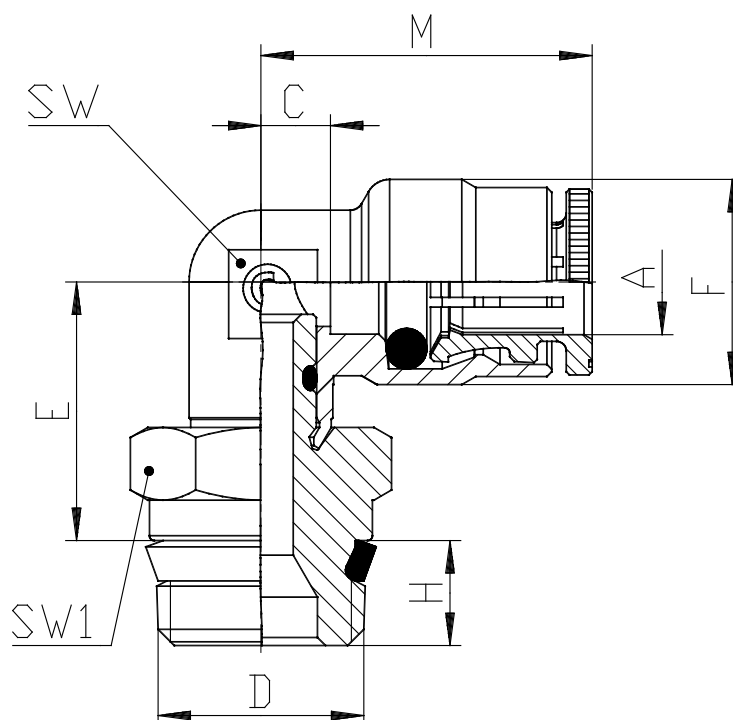

DIMENSIONS

A	1/8
D	1/8
C (INCH)	0.138
E (INCH)	0.610
F (INCH)	0.354
H (INCH)	0.197
M (INCH)	0.689
SW (INCH)	0.315
SW1 (INCH)	0.472