

Mod. P6520 - Fittings Serie 6000 inch

Product code: P6520 02-04

Datasheet creation date: 10/03/2025 10:30

Check the most updated document online [click here](#)



TECHNICAL DATA

Mod.	P6520 02-04
------	-------------

Mod. P6520 - Fittings Serie 6000 inch

Product code: P6520 02-04

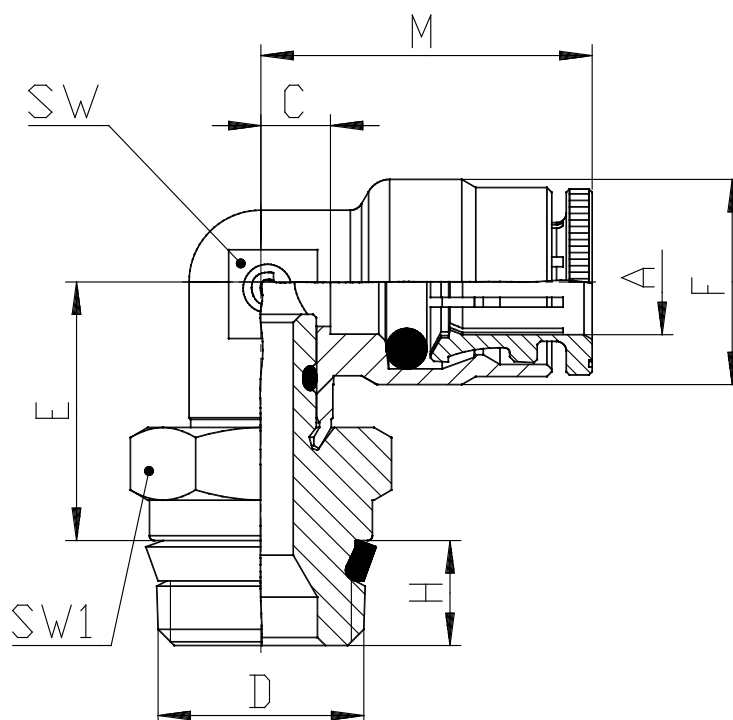

DIMENSIONS

A	1/8
D	1/4
C (INCH)	0.138
E (INCH)	0.650
F (INCH)	0.354
H (INCH)	0.256
M (INCH)	0.689
SW (INCH)	0.315
SW1 (INCH)	0.551