

Mod. P6520 - Fittings Serie 6000 inch

Product code: P6520 04-02

Datasheet creation date: 10/03/2025 10:30

Check the most updated document online [click here](#)



TECHNICAL DATA

Mod.	P6520 04-02
------	-------------

Mod. P6520 - Fittings Serie 6000 inch

Product code: P6520 04-02

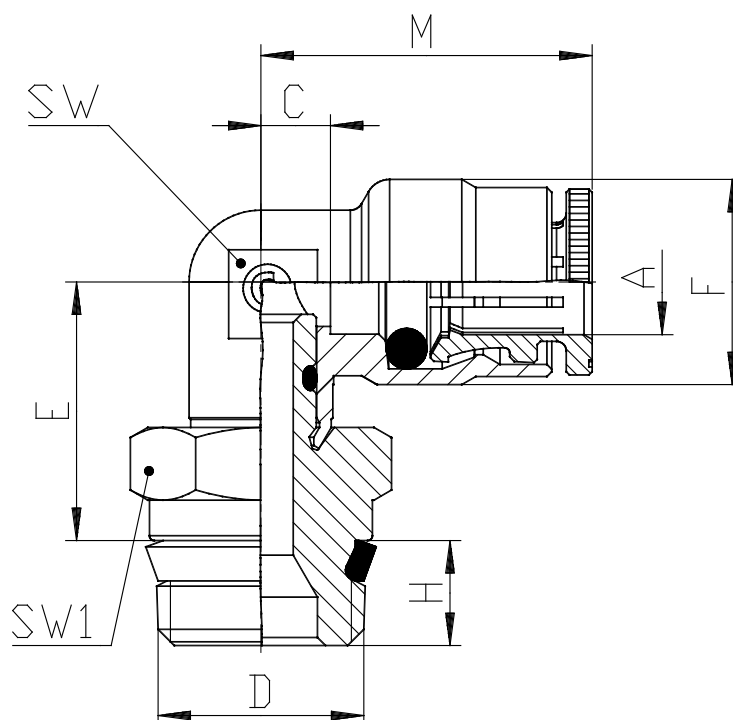

DIMENSIONS

A	1/4
D	1/8
C (INCH)	0.169
E (INCH)	0.610
F (INCH)	0.500
H (INCH)	0.197
M (INCH)	0.807
SW (INCH)	0.354
SW1 (INCH)	0.472