

Kit for parallel connection - Mod. PM

Product code: PM-3E-32-0024

Datasheet creation date: 07/03/2025 15:38

Check the most updated document online [click here](#)



TECHNICAL DATA

Mod.	PM-3E-32-0024
Motor	MTS-24-...
Protection	IP40

Kit for parallel connection - Mod. PM

Product code: PM-3E-32-0024

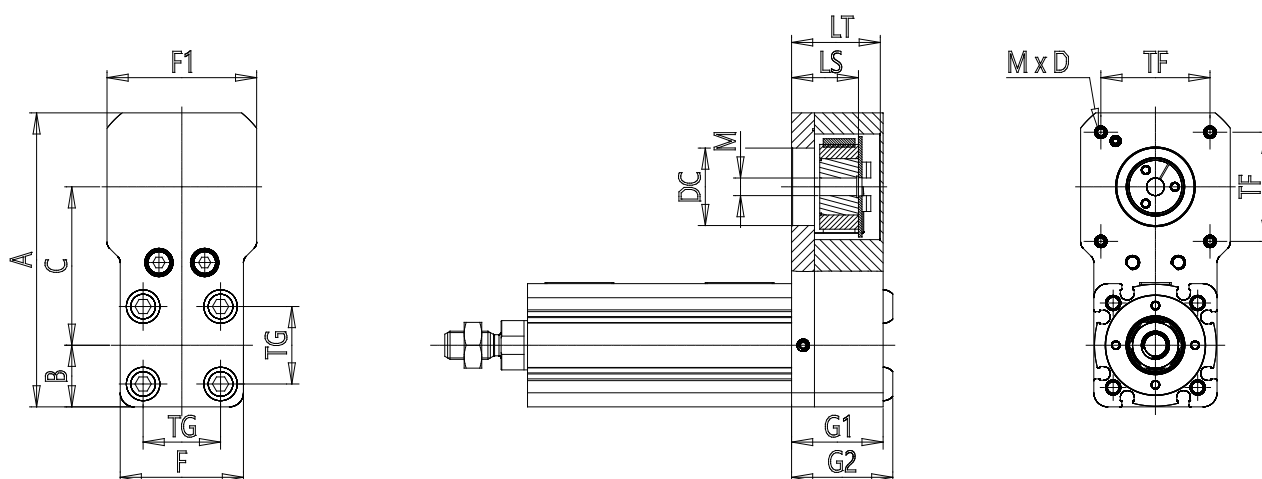

DIMENSIONS

A (mm)	116.5
B (mm)	21.0
C (mm)	67.5
F (mm)	42
F1 (mm)	56.5
TG (mm)	32.5
G1 (mm)	28
G2 (mm)	31.0
DC (mm)	38.1
M (mm)	8.00
LS (mm)	19
LT (mm)	26.5
TF (mm)	47.14
MxD	M4x6
J (kgmm²)	5.84
Weight (g)	390