

## Kit for parallel connection Mod. PM - Mod. PM

Product code: PM-5E-50-0024

Datasheet creation date: 07/03/2025 15:40

Check the most updated document online [click here](#)



### TECHNICAL DATA

<b>Mod.</b>	PM-5E-50-0024
<b>Size</b>	50
<b>Protection</b>	IP40
<b>Weight (g)</b>	530
<b>Efficiency</b>	0.62

## Kit for parallel connection Mod. PM - Mod. PM

Product code: PM-5E-50-0024

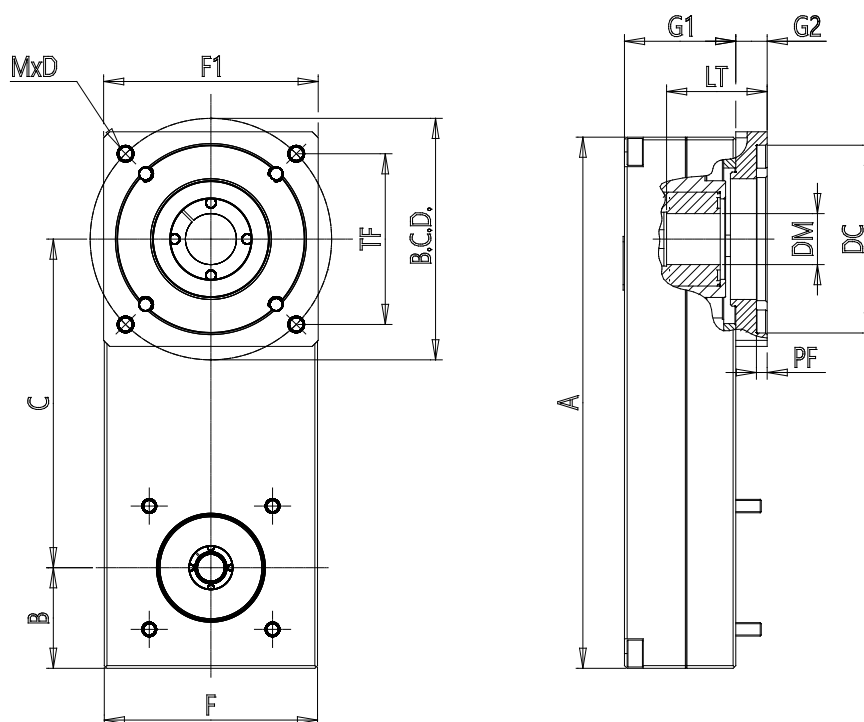

### DIMENSIONS

DC (mm)	38.1
DM (mm)	8
LT (mm)	22.5
BCD (mm)	0
TF (mm)	47.1
MxD	M4x6
PF (mm)	2.5
F (mm)	49.5
F1 (mm)	60
A (mm)	122.5
B (mm)	24.8
C (mm)	72.5
G1 (mm)	37.0
G2 (mm)	6.7
J (kg*mm <sup>2</sup> )	42.94