

Kit for parallel connection Mod. PM - Mod. PM

Product code: PM-5E-50-0100

Datasheet creation date: 07/03/2025 15:40

Check the most updated document online [click here](#)



TECHNICAL DATA

Mod.	PM-5E-50-0100
Size	50
Protection	IP40
Weight (g)	490
Efficiency	0.62

Kit for parallel connection Mod. PM - Mod. PM

Product code: PM-5E-50-0100

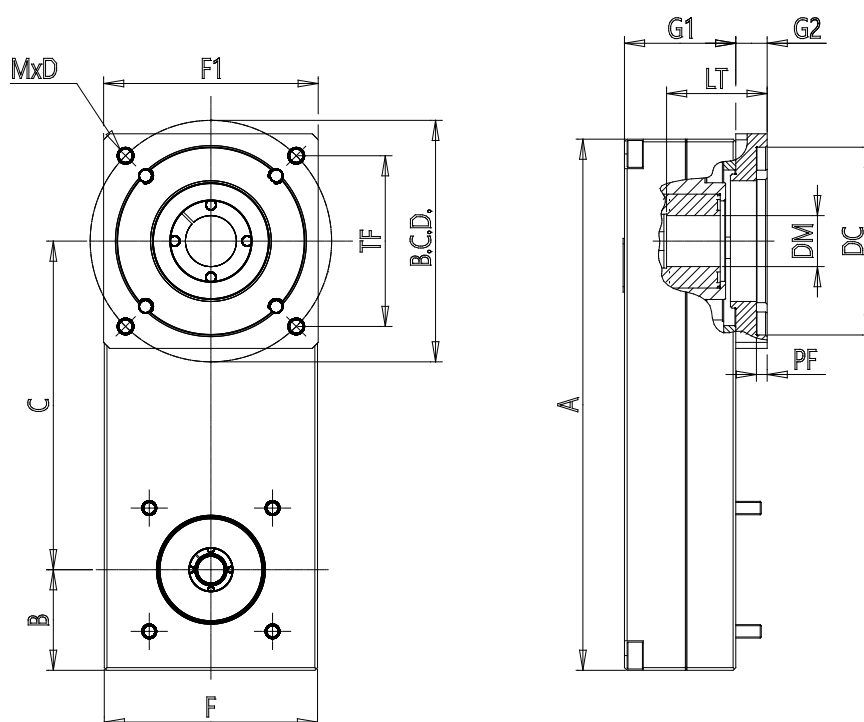

DIMENSIONS

DC (mm)	30.0
DM (mm)	8
LT (mm)	20.0
BCD (mm)	45
TF (mm)	0.0
MxD	M3x8
PF (mm)	6.0
F (mm)	49.5
F1 (mm)	0
A (mm)	122.5
B (mm)	24.8
C (mm)	72.5
G1 (mm)	37.0
G2 (mm)	0.0
J (kg*mm ²)	42.94