

Kit for parallel connection Mod. PM - Mod. PM

Product code: PM-5E-65-0400

Datasheet creation date: 07/03/2025 15:40

Check the most updated document online [click here](#)



TECHNICAL DATA

Mod.	PM-5E-65-0400
Size	65
Protection	IP40
Weight (g)	990
Efficiency	0.62

Kit for parallel connection Mod. PM - Mod. PM

Product code: PM-5E-65-0400

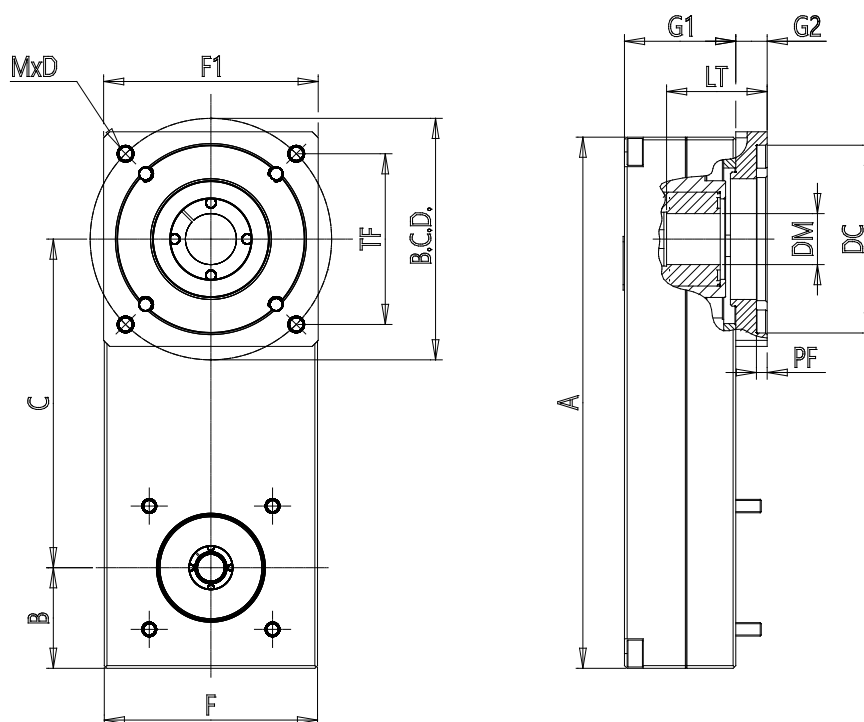

DIMENSIONS

DC (mm)	50.0
DM (mm)	14
LT (mm)	26.5
BCD (mm)	70
TF (mm)	0.0
MxD	M5x10
PF (mm)	4.0
F (mm)	64.5
F1 (mm)	0
A (mm)	164.5
B (mm)	32.0
C (mm)	94.5
G1 (mm)	42.0
G2 (mm)	0.0
J (kg*mm ²)	175.10