

## Kit for parallel connection Mod. PM - Mod. PM

Product code: PM-5E-80-0400

Datasheet creation date: 07/03/2025 15:40

Check the most updated document online [click here](#)



### TECHNICAL DATA

<b>Mod.</b>	PM-5E-80-0400
<b>Size</b>	80
<b>Protection</b>	IP40
<b>Weight (g)</b>	1160
<b>Efficiency</b>	0.62

## Kit for parallel connection Mod. PM - Mod. PM

Product code: PM-5E-80-0400

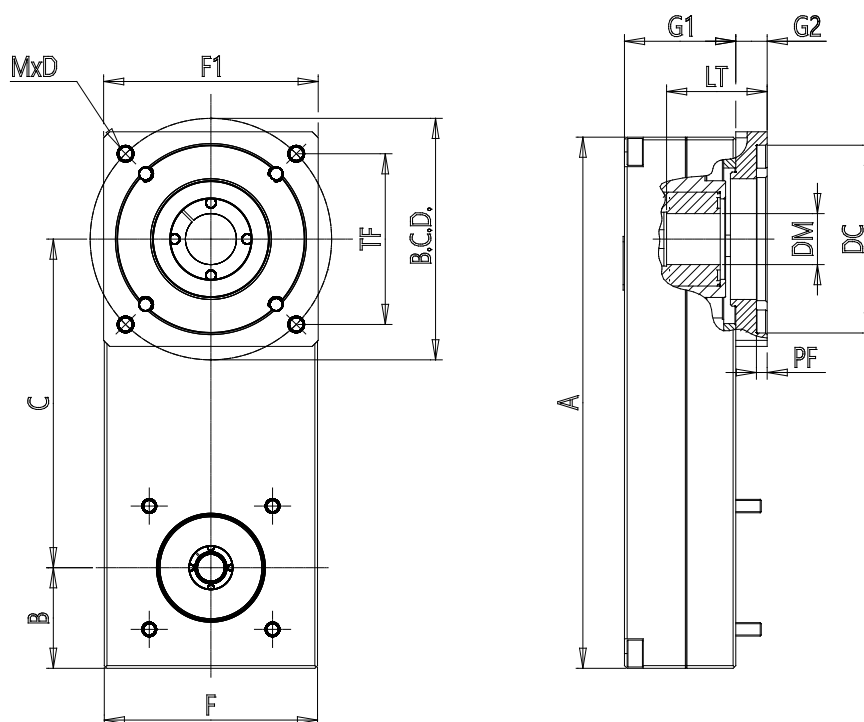

### DIMENSIONS

DC (mm)	50.0
DM (mm)	14
LT (mm)	27.0
BCD (mm)	70
TF (mm)	0.0
MxD	M5x10
PF (mm)	4.0
F (mm)	79.5
F1 (mm)	0
A (mm)	198.0
B (mm)	37.5
C (mm)	120.0
G1 (mm)	41.5
G2 (mm)	0.0
J (kg*mm <sup>2</sup> )	171.20