

Precision pressure regulators - Series PR

Product code: PR104-M07

Datasheet creation date: 10/03/2025 10:33

Check the most updated document online [click here](#)



TECHNICAL DATA

Series	PR
SIZE	1
PORTS	04= G1/4
TYPE OF ADJUSTMENT	M = manual
WORKING PRESSURE	07= 0.05 ÷ 7bar

Precision pressure regulators - Series PR

Product code: PR104-M07

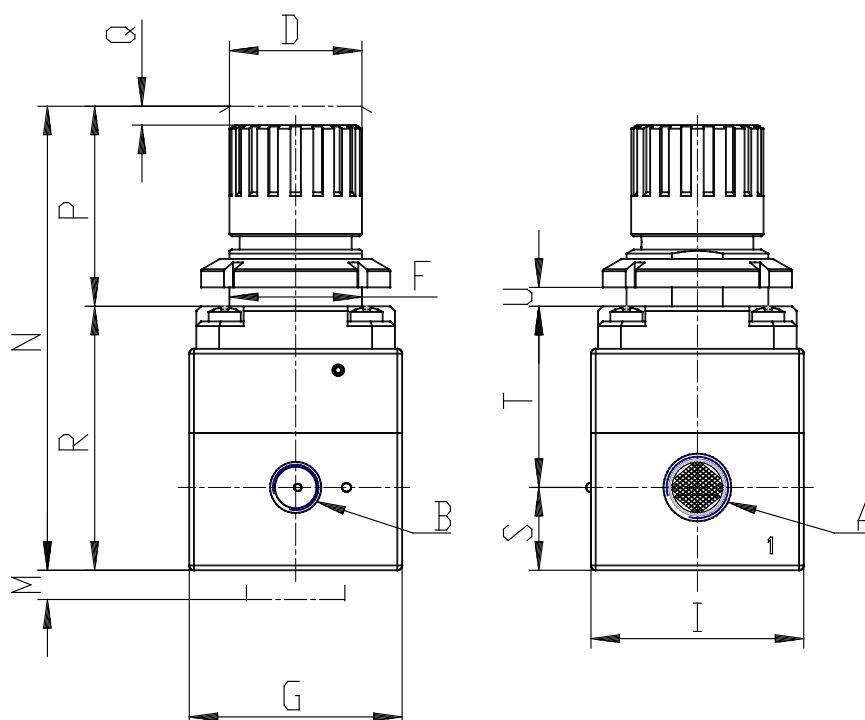

DIMENSIONS

A	G1/4
B	G1/8
D (mm)	28
F (mm)	30
G (mm)	45
I (mm)	45
M (mm)	25
N (mm)	96.0
P (mm)	40
Q (mm)	2
R (mm)	56.0
heavy (mm)	17.5
T (mm)	38.5
U	0 - 6
Weight (kg)	0,35