

Precision pressure regulators - Series PR

Product code: PR238-M04

Datasheet creation date: 10/03/2025 10:33

Check the most updated document online [click here](#)



TECHNICAL DATA

Series	PR
SIZE	2
PORTS	38= G3/8
TYPE OF ADJUSTMENT	M = manual
WORKING PRESSURE	04= 0.05 ÷ 4bar

Precision pressure regulators - Series PR

Product code: PR238-M04

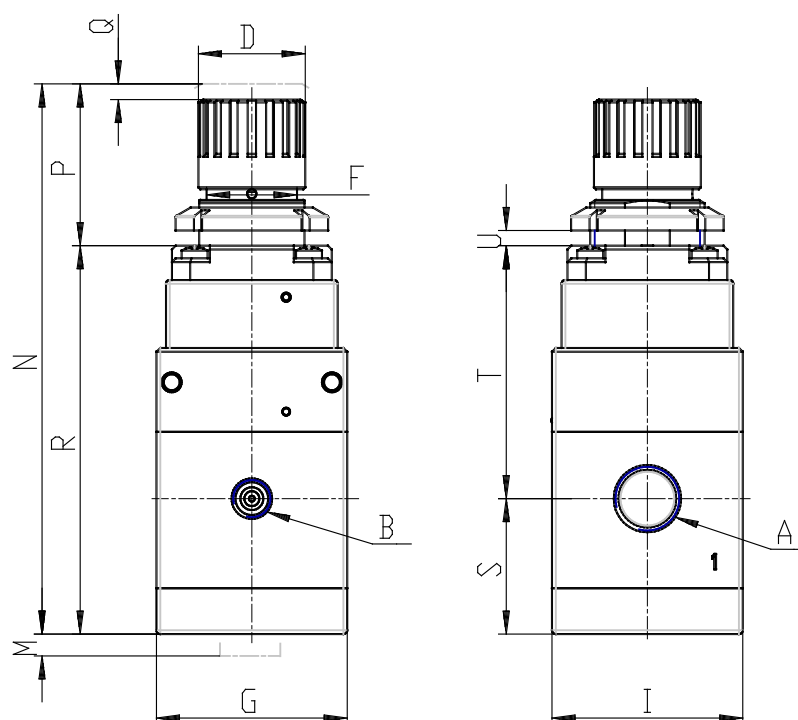

DIMENSIONS

A	G3/8
B	G1/8
D (mm)	28
F (mm)	30
G (mm)	50
I (mm)	50
M (mm)	25
N (mm)	141.8
P (mm)	40
Q (mm)	2
R (mm)	101.8
heavy (mm)	35.5
T (mm)	0.0
U	0 - 6
Weight (kg)	0.645