

## Precision pressure regulators - Series PR

Product code: PR238-M07

Datasheet creation date: 10/03/2025 10:33

Check the most updated document online [click here](#)



### TECHNICAL DATA

<b>Series</b>	PR
<b>SIZE</b>	2
<b>PORTS</b>	38= G3/8
<b>TYPE OF ADJUSTMENT</b>	M = manual
<b>WORKING PRESSURE</b>	07= 0.05 ÷ 7bar

## Precision pressure regulators - Series PR

Product code: PR238-M07

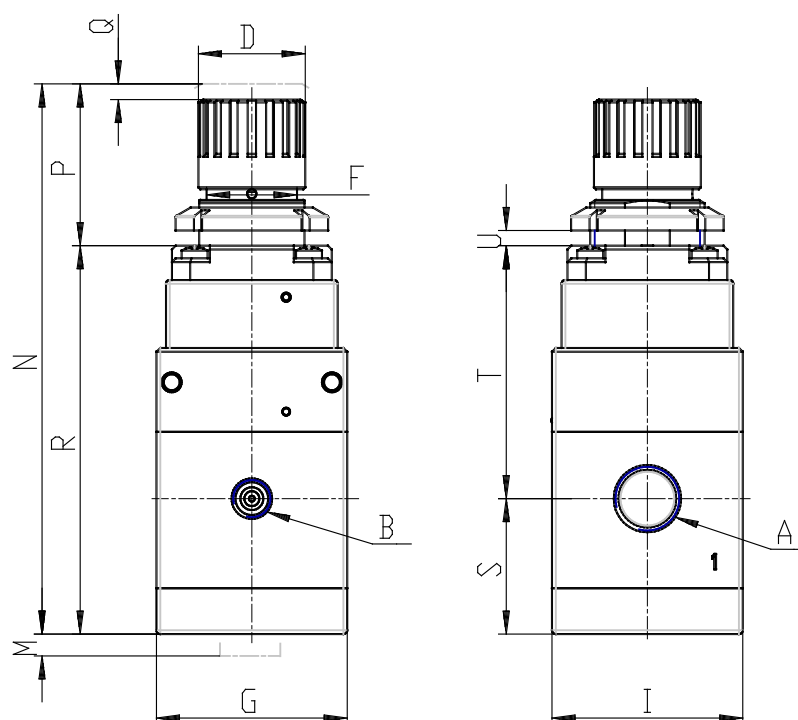

### DIMENSIONS

<b>A</b>	G3/8
<b>B</b>	G1/8
<b>D (mm)</b>	28
<b>F (mm)</b>	30
<b>G (mm)</b>	50
<b>I (mm)</b>	50
<b>M (mm)</b>	25
<b>N (mm)</b>	141.8
<b>P (mm)</b>	40
<b>Q (mm)</b>	2
<b>R (mm)</b>	101.8
<b>heavy (mm)</b>	35.5
<b>T (mm)</b>	0.0
<b>U</b>	0 - 6
<b>Weight (kg)</b>	0.645