

parallel connection kit - Mod. PS

Product code: PS-5E-50-0685

Datasheet creation date: 07/03/2025 15:40

Check the most updated document online [click here](#)



TECHNICAL DATA

Mod.	PS-5E-50
Size	50

parallel connection kit - Mod. PS

Product code: PS-5E-50-0685

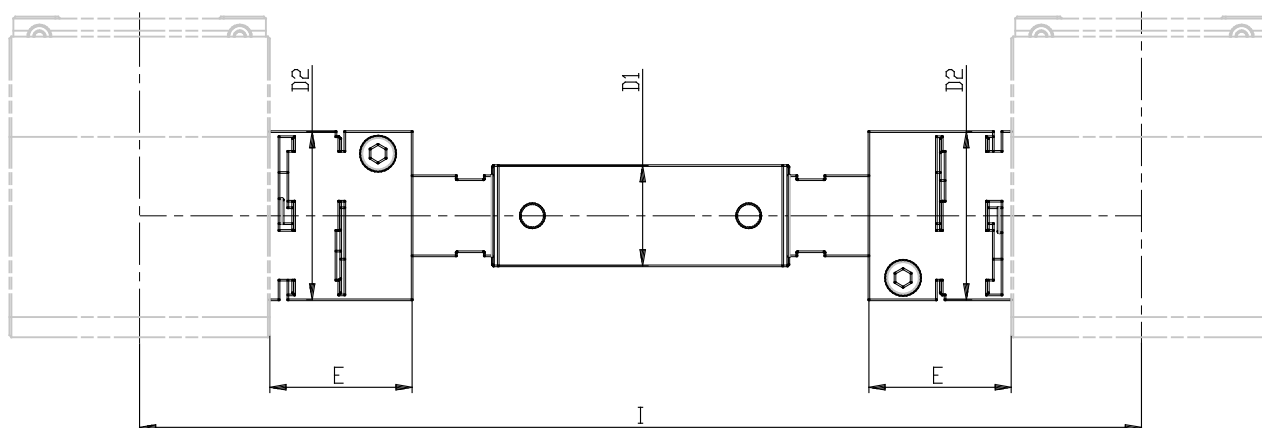

DIMENSIONS

I (mm)	685
D1 (mm)	16
D2 (mm)	32
E (mm)	26.0