

## parallel connection kit - Mod. PS

Product code: PS-5E-50-0750

Datasheet creation date: 07/03/2025 15:40

Check the most updated document online [click here](#)



### TECHNICAL DATA

<b>Mod.</b>	PS-5E-50
<b>Size</b>	50

## parallel connection kit - Mod. PS

Product code: PS-5E-50-0750

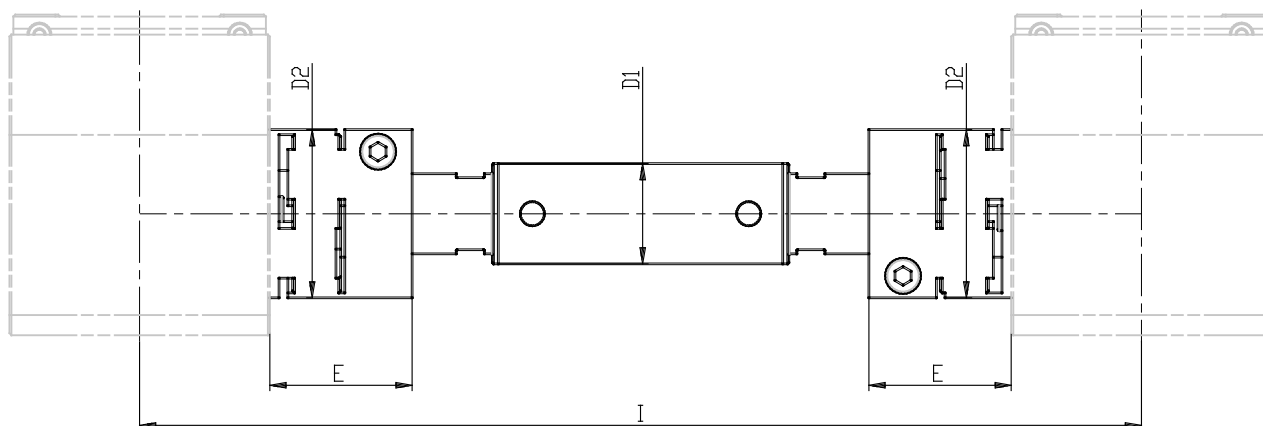

### **DIMENSIONS**

I (mm)	750
D1 (mm)	16
D2 (mm)	32
E (mm)	26.0