

parallel connection kit - Mod. PS

Product code: PS-5E-65-0390

Datasheet creation date: 07/03/2025 15:40

Check the most updated document online [click here](#)



TECHNICAL DATA

Mod.	PS-5E-65
Size	65

parallel connection kit - Mod. PS

Product code: PS-5E-65-0390

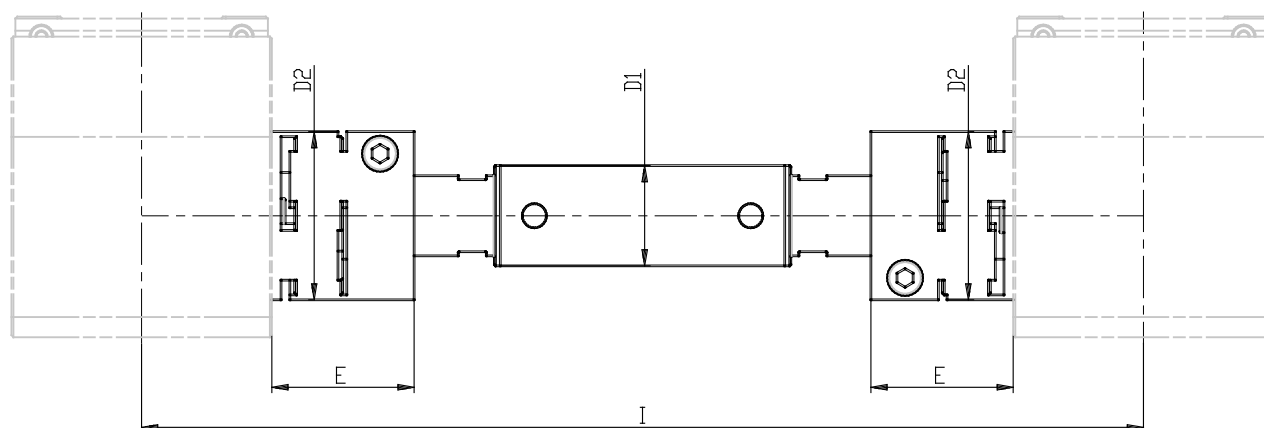

DIMENSIONS

I (mm)	390
D1 (mm)	25
D2 (mm)	42
E (mm)	35.5