

## parallel connection kit - Mod. PS

Product code: PS-5E-65-0670

Datasheet creation date: 07/03/2025 15:40

Check the most updated document online [click here](#)



### TECHNICAL DATA

<b>Mod.</b>	PS-5E-65
<b>Size</b>	65

## parallel connection kit - Mod. PS

Product code: PS-5E-65-0670

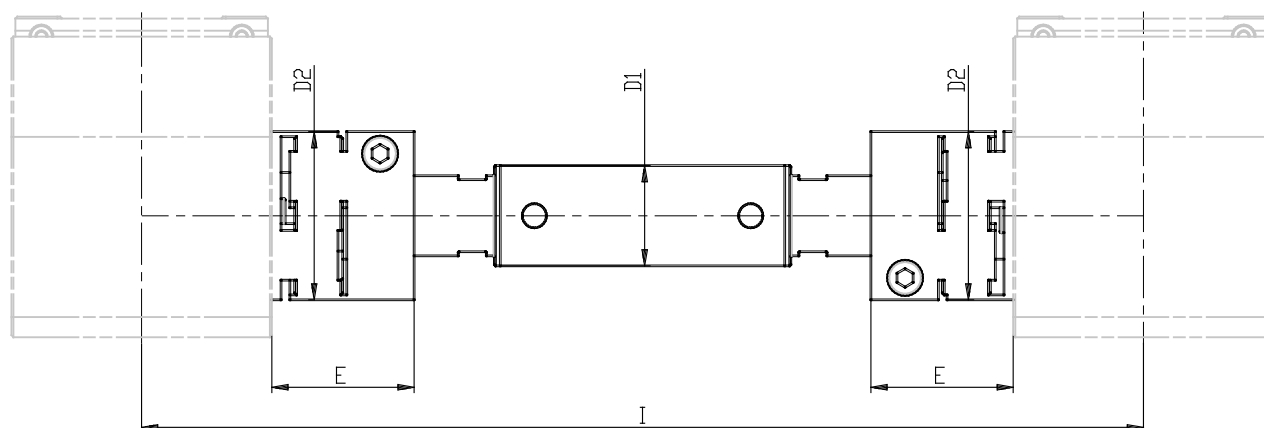

### **DIMENSIONS**

I (mm)	670
D1 (mm)	25
D2 (mm)	42
E (mm)	35.5